



POWER SYSTEMS

# AESFULAP<sup>®</sup> BURRS & BLADES

CATALOG 2020

# AESCULAP® BURRS & BLADES

POWER SYSTEMS



## CONTENT – INHALT – SOMMAIRE – ÍNDICE – INDICE

<b>› SAGITTAL SAW BLADES (OSCILLATING SAW BLADES)</b>	<b>5 – 20</b>
Sagittale Sägeblätter (oszillierende Sägeblätter) – Lames de scie sagittale (lames oscillantes) – Hojas de sierra sagitales (hojas de sierra oscilantes) – Lame per sega sagittale (lame per sega oscillante)	
<b>› RECIPROCATING SAW BLADES</b>	<b>21 – 30</b>
Stichsägeblätter – Lames de scie alternative – Hojas de sierra de punta – Lame per sega reciprocant	
<b>› TRANSVERSAL SAW BLADES</b>	<b>31 – 38</b>
Transversalsägeblätter – Lames de scie transversale – Hojas de sierra transversal – Lame per sega trasversale	
<b>› ELAN 4 BURRS</b>	<b>39 – 50</b>
ELAN 4 Fräser – Fraises ELAN 4 – Fresa ELAN 4 – Fresa ELAN 4	
<b>› Hi-Line XS BURRS</b>	<b>51 – 56</b>
Hi-Line XS Fräser – Fraises Hi-Line XS – Fresa Hi-Line XS – Fresa Hi-Line XS	
<b>› Hi-Line BURRS</b>	<b>57 – 60</b>
Hi-Line Fräser – Fraises Hi-Line – Fresa Hi-Line – Fresa Hi-Line	
<b>› 2.35 mm BURRS</b>	<b>61 – 66</b>
2,35 mm Fräser – Fraises 2,35 mm – Fresa 2,35 mm – Fresa 2,35 mm	
<b>› TWIST DRILLS, INTRAMEDULLARY REAMERS</b>	<b>67 – 70</b>
Spiralbohrer, Markraumborher – Forets hélicoïdaux, foret intramédullaire – Broca helicoidal, broca para cavidad medular – Perforatore spiralato, perforatore midollare	
<b>› SKULL PERFORATORS, CRANIOTOME BURRS</b>	<b>71 – 72</b>
Schädeltrepane, Kraniotomfräser – Trépans crâniens, fraises de craniotome – Trépanos y fresas para craneótomo – Perforatori cranici, frese per craniotomia	
<b>› OTHERS</b>	<b>73 – 76</b>
Sonstige – Divers – Otros – Altro	
<b>› INDEX, UNIVERSAL TOOL ATTACHMENTS, SIGNS AND SYMBOLS</b>	<b>77 – 84</b>
Index, Universelle Werkzeuganschlüsse, Zeichenerklärung – Sommaire, Raccords d'outil universels, Explication des symboles – Índice, Conexiones universales para útiles, Explicación de los símbolos – Indice, Attacchi utensili universali, Spiegazione dei simboli	

All measurements and technical data listed in this brochure are approximate as they are subject to normal manufacturing tolerances and to technical modifications.

Alle Maße und technischen Daten in diesem Katalog sind Nennmaße, welche anerkannten fertigungsbedingten Toleranzen unterliegen und sind vorbehaltlich technischer Änderungen.

Toutes les dimensions et données techniques figurant dans ce catalogue sont des valeurs nominales soumises à des tolérances de fabrication reconnues et fournies sous réserve de modifications techniques.

Todas las medidas y datos técnicos de este catálogo son medidas nominales que están sujetas a tolerancias de fabricación reconocidas y, por tanto, a modificaciones técnicas.

Tutte le misurazioni e le specifiche tecniche contenute in questo catalogo sono solo nominali in quanto soggette alle normali tolleranze di fabbricazione e a eventuali modifiche tecniche.

# AESCULAP® BURRS & BLADES

## SAGITTAL SAW BLADES (OSCILLATING SAW BLADES)

Sagittale Sägeblätter (oszillierende Sägeblätter)

Lames de scie sagittale (lames oscillantes)

Hojas de sierra sagitales (hojas de sierra oscilantes)

Lame per sega sagittale (lame per sega oscillante)

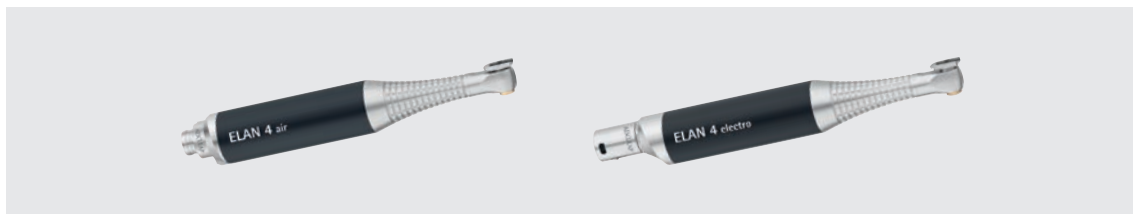

GA736

GA836

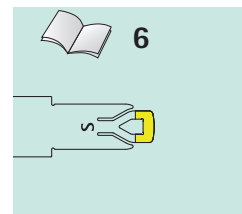

GA731

GA831

GB891R

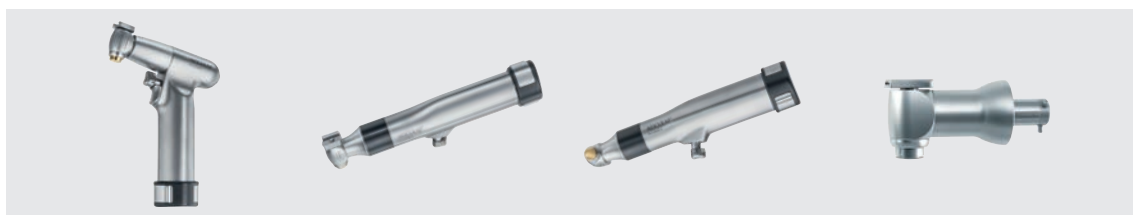
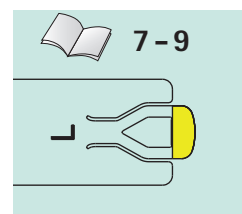

GA331

GA336

GA337

GB660R

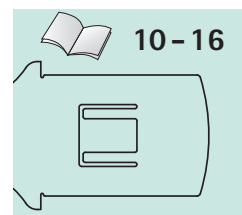

GD307

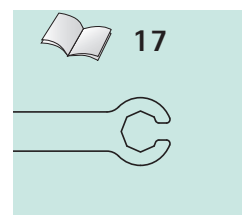

GB390R

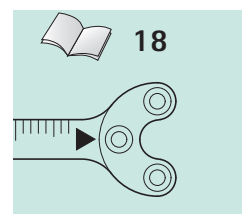

GB129

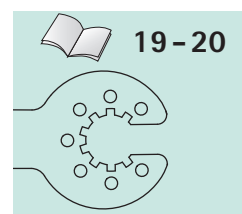

# AESCULAP® BURRS & BLADES







## SAGITTAL SAW BLADES (OSCILLATING SAW BLADES)

Sagittale Sägeblätter (oszillierende Sägeblätter)

Lames de scie sagittale (lames oscillantes)

Hojas de sierra sagitales (hojas de sierra oscilantes)

Lame per sega sagittale (lame per sega oscillante)

	 sterile					
<b>GP491R</b>		14 mm	13 mm	0.3 mm	0.3 mm	<b>» GA736, GA836</b>  
<b>GP492R</b>		15 mm	5 mm	0.3 mm	0.3 mm	
<b>GP493R</b>		20 mm	5 mm	0.3 mm	0.3 mm	
<b>GP494R</b>		20 mm	10 mm	0.3 mm	0.3 mm	
<b>GP495R</b>		20 mm	15 mm	0.3 mm	0.3 mm	
<b>GP496R</b>		25 mm	5 mm	0.3 mm	0.3 mm	
<b>GP497R</b>		25 mm	12 mm	0.3 mm	0.3 mm	

GP491R

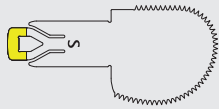

GP496R

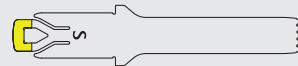

GP492R



GP497R

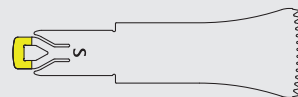

GP493R



GP494R

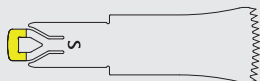

GP495R

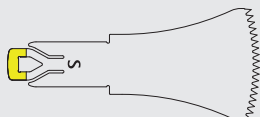



1 sterile



GP501R	15 mm	5 mm	0.5 mm	0.5 mm
GP502R	15 mm	10 mm	0.5 mm	0.5 mm
GP504R	20 mm	5 mm	0.5 mm	0.5 mm
GP505R	20 mm	10 mm	0.5 mm	0.5 mm
GP514R	25 mm	5 mm	0.5 mm	0.7 mm
GP515R	25 mm	10 mm	0.5 mm	0.7 mm
GP516R	25 mm	15 mm	0.5 mm	0.7 mm
GP518R	35 mm	10 mm	0.5 mm	0.5 mm
GP521R	35 mm	5 mm	0.5 mm	0.5 mm
GP522R	35 mm	10 mm	0.5 mm	0.7 mm
GP523R	35 mm	15 mm	0.5 mm	0.7 mm
GP524R	35 mm	20 mm	0.5 mm	0.7 mm

» GA731, GA831, GB891R



GP501R

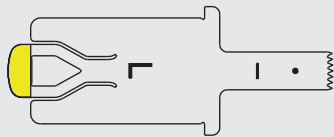

GP502R

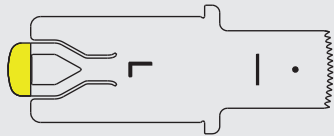

GP504R

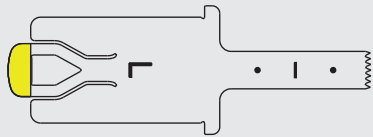

GP505R

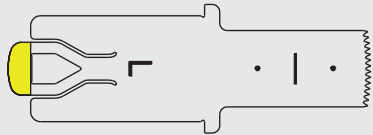

GP514R

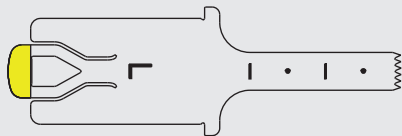

GP515R

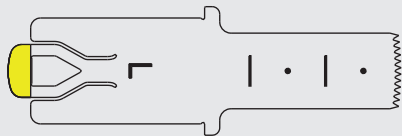

GP516R

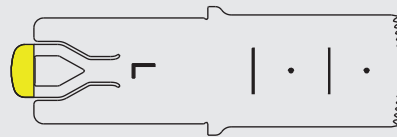

GP518R

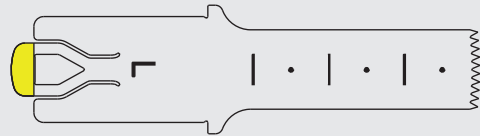

GP521R

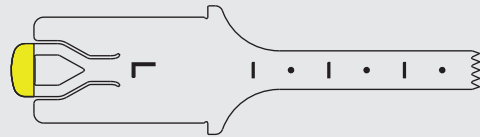

GP522R

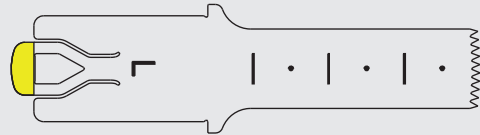

GP523R

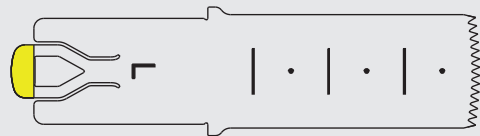

GP524R



# AESCU LAP<sup>®</sup> BURRS & BLADES







## SAGITTAL SAW BLADES (OSCILLATING SAW BLADES)

Sagittale Sägeblätter (oszillierende Sägeblätter)

Lames de scie sagittale (lames oscillantes)

Hojas de sierra sagitales (hojas de sierra oscilantes)

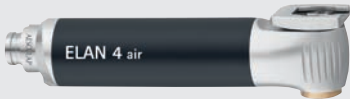
Lame per sega sagittale (lame per sega oscillante)

	 sterile					
<b>GP535R</b>		50 mm	10 mm	0.5 mm	0.8 mm	<b>» GA731, GA831, GB891R</b>   
<b>GP536R</b>		50 mm	15 mm	0.5 mm	0.8 mm	
<b>GP537R</b>		50 mm	20 mm	0.7 mm	0.9 mm	
<b>GP538R</b>		50 mm	25 mm	0.7 mm	0.9 mm	
<b>GP539R</b>		50 mm	30 mm	0.7 mm	0.9 mm	

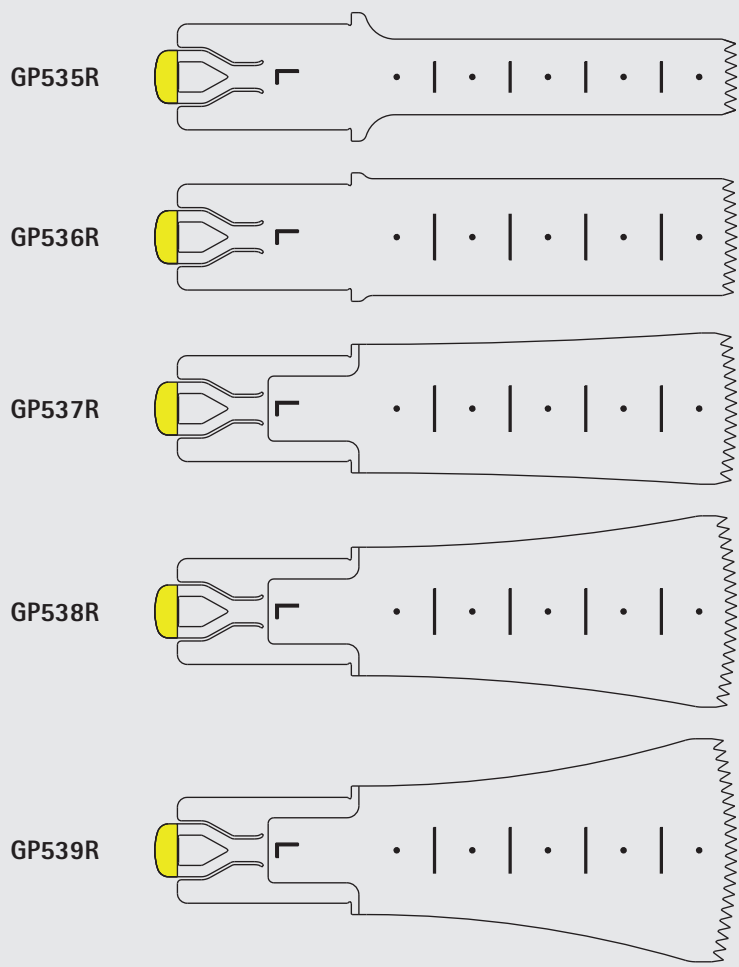





1 sterile



GP511R

35 mm

10 mm

0.5 mm

0.5 mm

10 mm

» GA731, GA831, GB891R

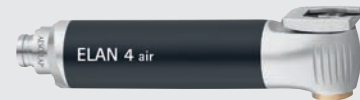

GP511R

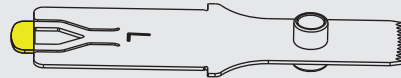
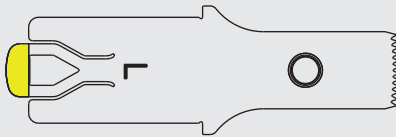

1 sterile



GP526R

51 mm

15 mm

0.5 mm

6 mm

20 mm

» GA731, GA831

GP527R

51 mm

15 mm

0.5 mm

7 mm

20 mm

GP528R

51 mm

15 mm

0.5 mm

8 mm

20 mm

GP529R

51 mm

15 mm

0.5 mm

9 mm

20 mm

GP530R

51 mm

15 mm

0.5 mm

10 mm

20 mm

GP531R

51 mm

15 mm

0.5 mm

11 mm

20 mm

GP532R

51 mm

15 mm

0.5 mm

12 mm

20 mm

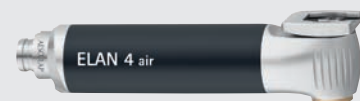

GP526R -  
GP532R

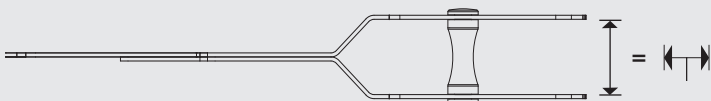
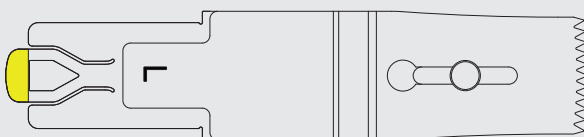

# AESCU LAP<sup>®</sup> BURRS & BLADES







## SAGITTAL SAW BLADES (OSCILLATING SAW BLADES)



Sagittale Sägeblätter (oszillierende Sägeblätter)

Lames de scie sagittale (lames oscillantes)

Hojas de sierra sagitales (hojas de sierra oscilantes)

Lame per sega sagittale (lame per sega oscillante)

	 sterile							
<b>GC203R</b>		25 mm	10 mm	0.5 mm	0.5 mm	10 mm	<b>» GA331, GA336</b> <b>GA673, GA668</b>	<b>» GB660R</b>
<b>GC207R</b>		25 mm	5 mm	0.5 mm	0.5 mm			
<b>GC208R</b>		25 mm	15 mm	0.5 mm	0.5 mm			
<b>GC209R</b>		35 mm	10 mm	0.5 mm	0.8 mm			
<b>GC211R</b>		35 mm	20 mm	0.5 mm	0.8 mm			



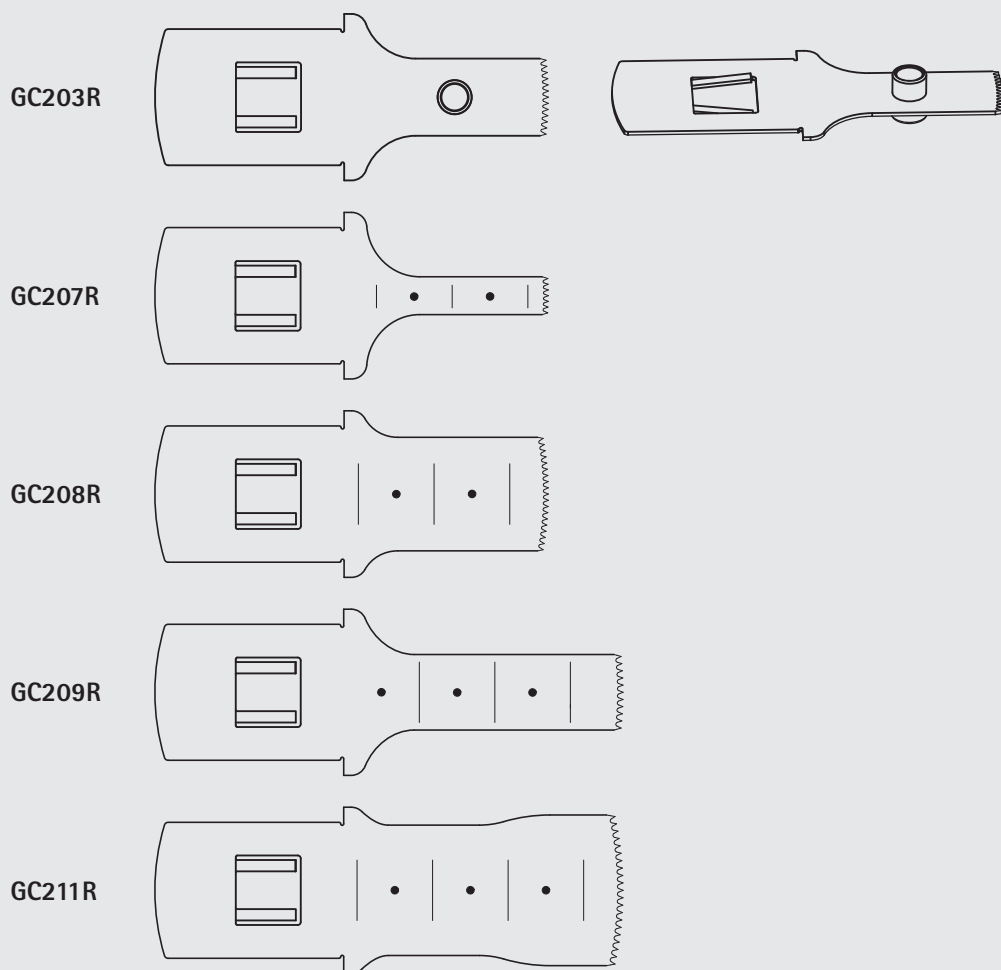

1 sterile



GC215R	50 mm	10 mm	0.5 mm	0.8 mm
GC216R	50 mm	15 mm	0.5 mm	0.8 mm
GC217R	50 mm	20 mm	0.7 mm	0.9 mm
GC218R	50 mm	25 mm	0.7 mm	0.9 mm
GC219R	50 mm	30 mm	0.7 mm	0.9 mm

» GA331, GA336  
GA673, GA668

» GB660R

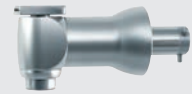

GC215R

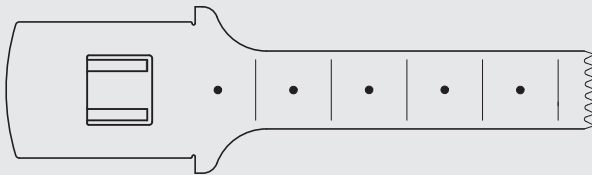

GC216R

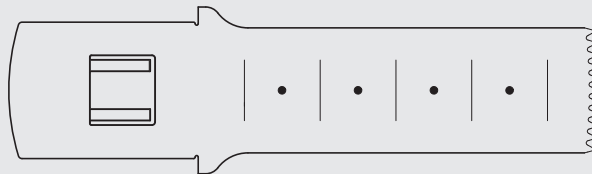

GC217R

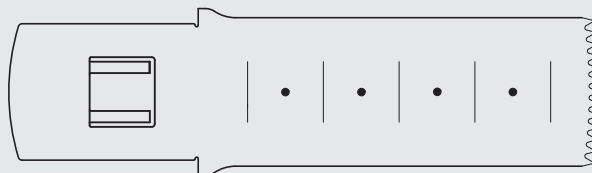

GC218R

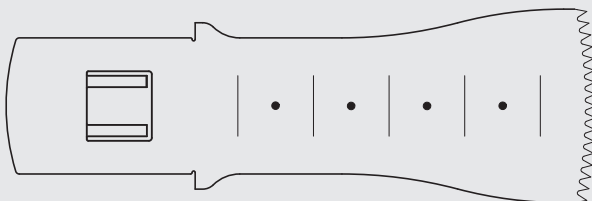

GC219R

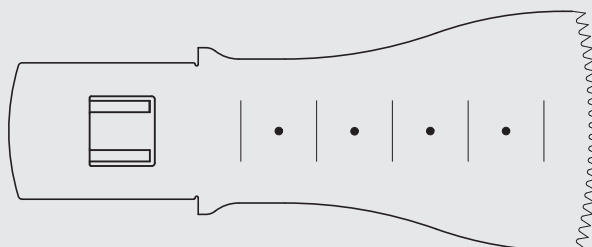

# AESULAP® BURRS & BLADES

## SAGITTAL SAW BLADES (OSCILLATING SAW BLADES)

Sagittale Sägeblätter (oszillierende Sägeblätter)

Lames de scie sagittale (lames oscillantes)

Hojas de sierra sagitales (hojas de sierra oscilantes)

Lame per sega sagittale (lame per sega oscillante)



<b>GE231SU</b>	75 mm	9.0 mm	1.27 mm			<b>» GA331, GA336, GA673, GA668</b> 
<b>GE232SU</b>	90 mm	13.5 mm	1.47 mm			
<b>GE233SU</b>	90 mm	13.5 mm	1.27 mm			
<b>GE234SU</b>	90 mm	13.0 mm	0.89 mm			
<b>GE235SU</b>	90 mm	13.0 mm	1.00 mm			
<b>GE236SU</b>	90 mm	13.0 mm	1.27 mm			
<b>GE238SU</b>	90 mm	19.0 mm	0.89 mm			
<b>GE239SU</b>	90 mm	19.0 mm	1.00 mm			
<b>GE240SU</b>	90 mm	19.0 mm	1.19 mm			
<b>GE241SU</b>	90 mm	19.0 mm	1.27 mm			
<b>GE242SU</b>	90 mm	19.0 mm	1.37 mm			

**GE231SU**

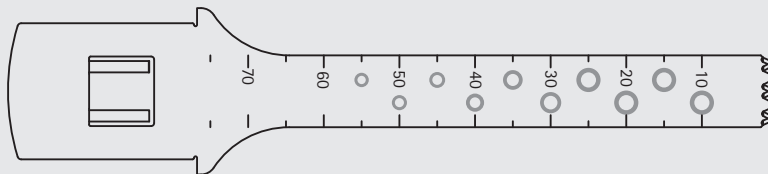

**GE232SU -  
GE233SU**

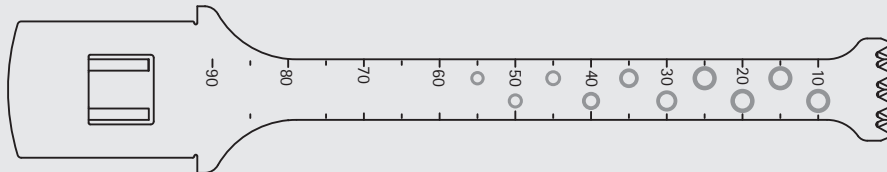

**GE234SU -  
GE236SU**

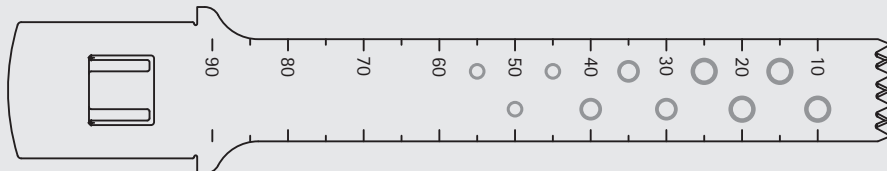

**GE238SU -  
GE242SU**

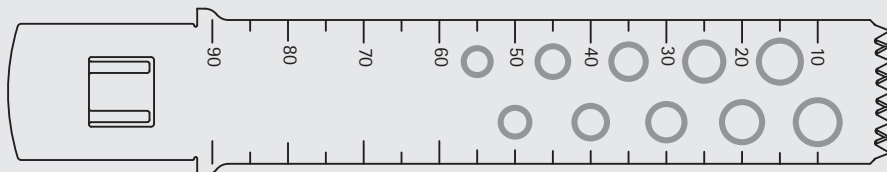



<b>GE243SU</b>	90 mm	23 mm	0.89 mm		<b>» GA331, GA336, GA673, GA668</b> 
<b>GE244SU</b>	90 mm	23 mm	1.00 mm		
<b>GE245SU</b>	90 mm	23 mm	1.19 mm		
<b>GE246SU</b>	90 mm	23 mm	1.27 mm		
<b>GE247SU</b>	90 mm	23 mm	1.37 mm		
<b>GE248SU</b>	90 mm	23 mm	1.47 mm		
<b>GE249SU</b>	100 mm	19 mm	1.27 mm		

**GE243SU -  
GE248SU**

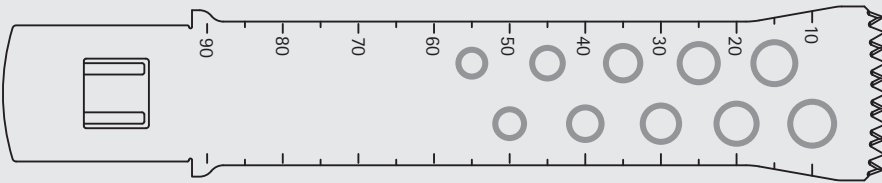

**GE249SU**

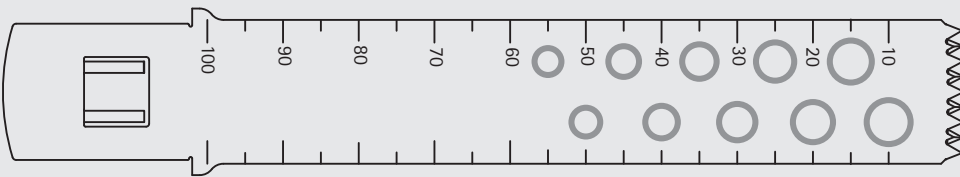

# AESCU LAP<sup>®</sup> BURRS & BLADES

## SAGITTAL SAW BLADES (OSCILLATING SAW BLADES)

Sagittale Sägeblätter (oszillierende Sägeblätter)

Lames de scie sagittale (lames oscillantes)

Hojas de sierra sagitales (hojas de sierra oscilantes)

Lame per sega sagittale (lame per sega oscillante)



GE252R	65 mm	20 mm	0.9 mm
GE253R	65 mm	26 mm	0.9 mm
GE254R	65 mm	32 mm	0.9 mm
GE255R	65 mm	41 mm	0.9 mm

» GA331, GA336, GA673, GA668

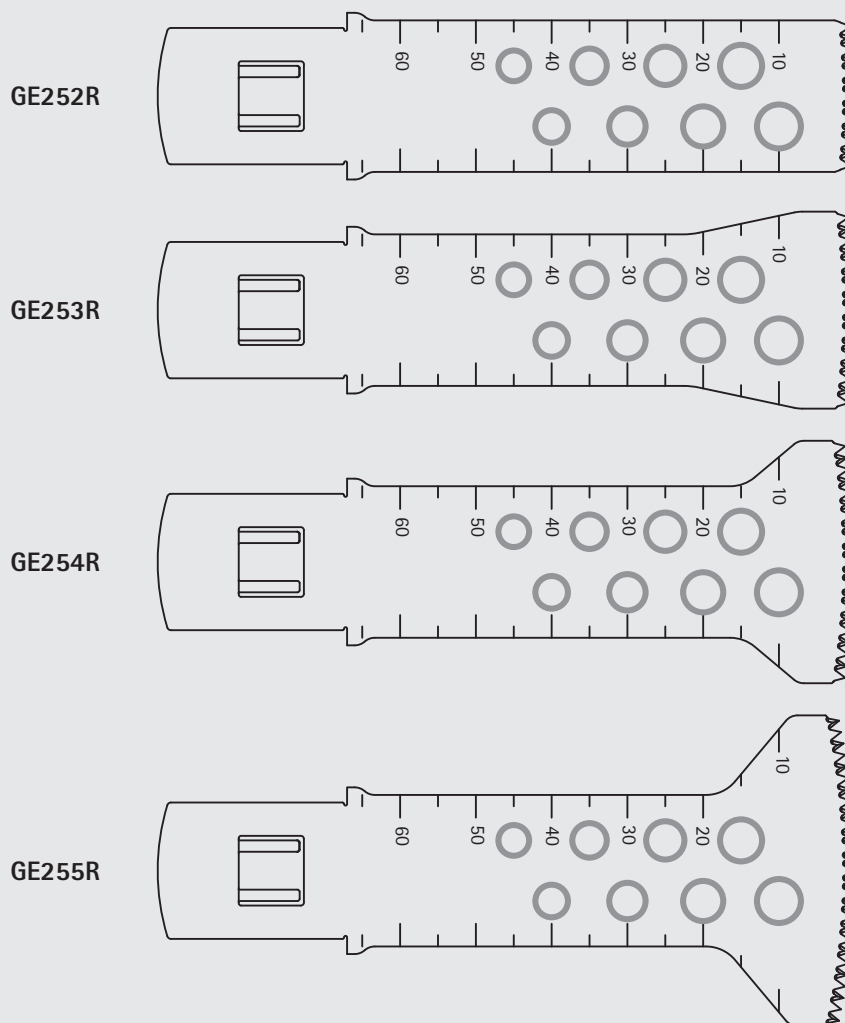



1 sterile



GC211R	35 mm	20 mm	0.5 mm	0.8 mm
GC675R	50 mm	40 mm	0.7 mm	0.9 mm
GC681R	35 mm	75 mm	0.7 mm	0.9 mm

» GA331, GA336  
GA673, GA668

» GB660R

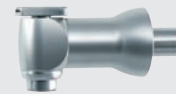

GC211R

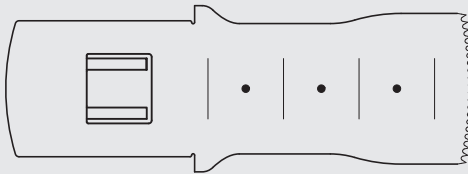

GC675R

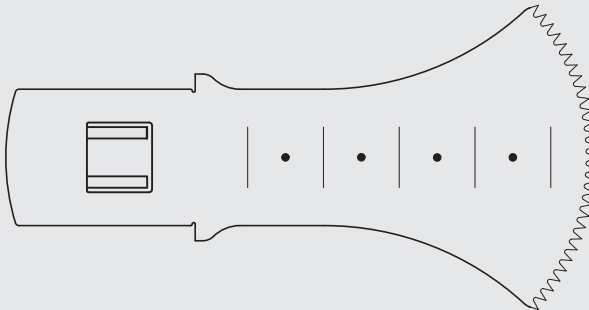

GC681R

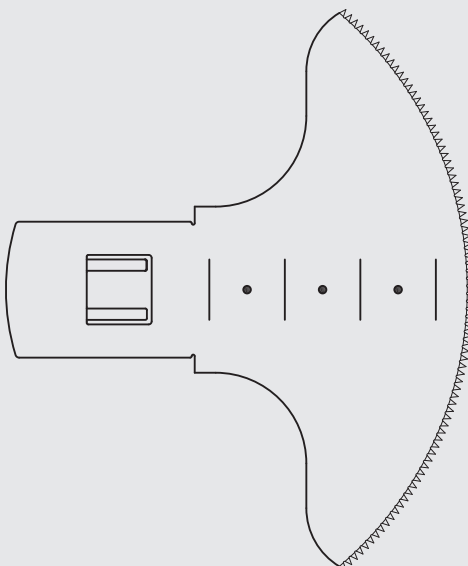

# AESCULAP® BURRS & BLADES

## SAGITTAL SAW BLADES (OSCILLATING SAW BLADES)

Sagittale Sägeblätter (oszillierende Sägeblätter)

Lames de scie sagittale (lames oscillantes)

Hojas de sierra sagitales (hojas de sierra oscilantes)

Lame per sega sagittale (lame per sega oscillante)



<b>GC682R</b>	35 mm	75 mm	0.7 mm	0.9 mm
<b>GC683R</b>	50 mm	17 mm	0.7 mm	0.9 mm

» GA336, GA337, GA668



GC682R

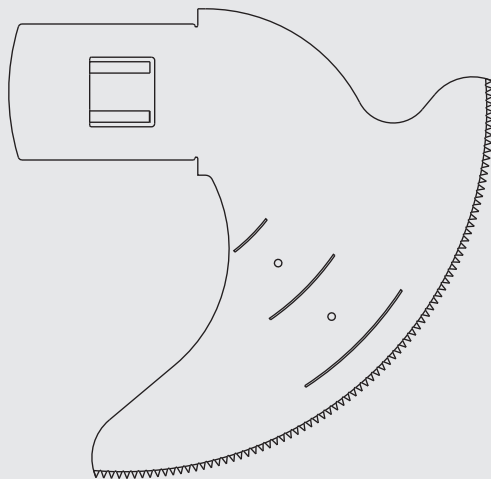

GC683R

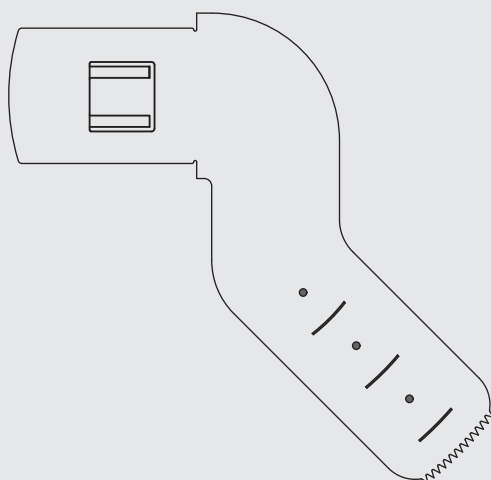





5 sterile



GD390R	10 mm	13.0 mm	0.3 mm	0.3 mm
GD391R	9 mm	13.0 mm	0.3 mm	0.3 mm
GD392R	15 mm	5.0 mm	0.3 mm	0.3 mm
GD393R	20 mm	5.0 mm	0.3 mm	0.3 mm
GD394R	20 mm	12.0 mm	0.3 mm	0.3 mm
GD395R	20 mm	15.0 mm	0.3 mm	0.3 mm
GD396R	25 mm	5.0 mm	0.3 mm	0.3 mm
GD397R	25 mm	12.0 mm	0.3 mm	0.3 mm

» GD307



GD390R

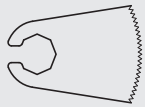

GD395R

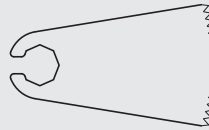

GD391R

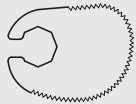

GD396R

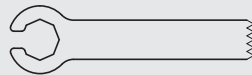

GD392R



GD397R

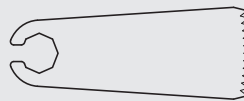

GD393R

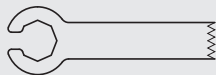

GD394R



# AESCULAP® BURRS & BLADES







## SAGITTAL SAW BLADES (OSCILLATING SAW BLADES)

Sagittale Sägeblätter (oszillierende Sägeblätter)

Lames de scie sagittale (lames oscillantes)

Hojas de sierra sagitales (hojas de sierra oscilantes)

Lame per sega sagittale (lame per sega oscillante)

	 sterile					
<b>GC114R</b>		15 mm	5 mm	0.35 mm	0.5 mm	<b>»GB390R</b> 
<b>GC115R</b>		15 mm	10 mm	0.35 mm	0.5 mm	
<b>GC124R</b>		20 mm	5 mm	0.35 mm	0.5 mm	
<b>GC125R</b>		20 mm	10 mm	0.35 mm	0.5 mm	
<b>GC127R</b>		20 mm	5 mm	0.50 mm	0.7 mm	
<b>GC128R</b>		20 mm	10 mm	0.50 mm	0.7 mm	
<b>GC137R</b>		25 mm	5 mm	0.50 mm	0.7 mm	
<b>GC138R</b>		25 mm	10 mm	0.50 mm	0.7 mm	
<b>GC139R</b>		25 mm	15 mm	0.50 mm	0.7 mm	
<b>GC148R</b>		35 mm	10 mm	0.50 mm	0.7 mm	
<b>GC149R</b>		35 mm	15 mm	0.50 mm	0.7 mm	

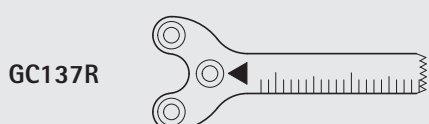
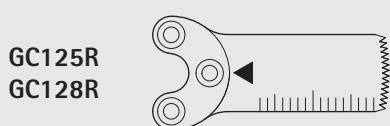
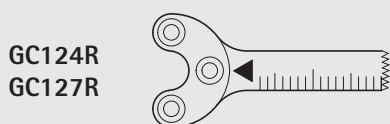
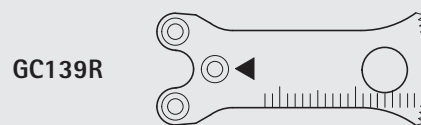
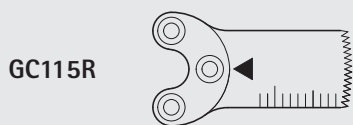
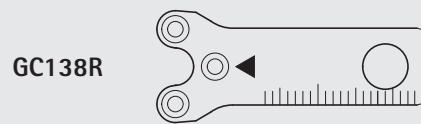
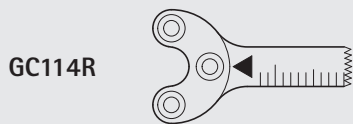



GC604R	25 mm	5 mm	0.5 mm	0.5 mm	
GC605R	25 mm	10 mm	0.5 mm	0.5 mm	
GC634R	35 mm	5 mm	0.5 mm	0.5 mm	
GC635R	35 mm	10 mm	0.5 mm	0.8 mm	
GC636R	35 mm	20 mm	0.5 mm	0.8 mm	
GC640R	50 mm	15 mm	0.5 mm	6.0 mm	18.5 mm
GC641R	50 mm	15 mm	0.5 mm	7.0 mm	18.5 mm
GC642R	50 mm	15 mm	0.5 mm	8.0 mm	18.5 mm
GC643R	50 mm	15 mm	0.5 mm	9.0 mm	18.5 mm
GC644R	50 mm	15 mm	0.5 mm	10.0 mm	18.5 mm
GC645R	50 mm	15 mm	0.5 mm	11.0 mm	18.5 mm
GC646R	50 mm	15 mm	0.5 mm	12.0 mm	18.5 mm

» GB129

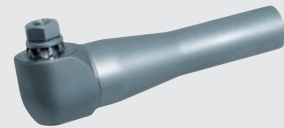

GC604R

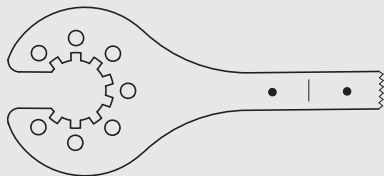

GC636R



GC605R

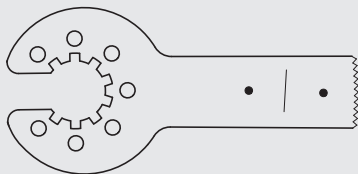

GC640R -  
GC646R

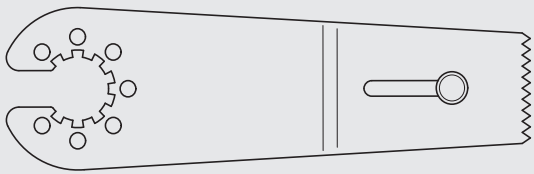

GC634R

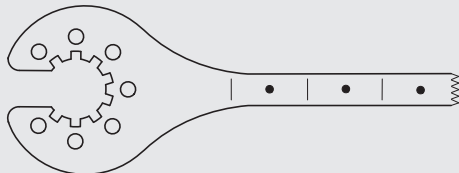

GC635R

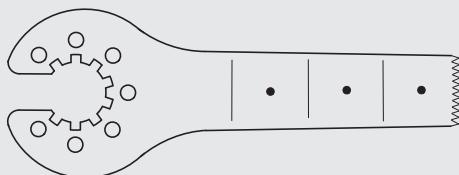

# AESCULAP® BURRS & BLADES

## SAGITTAL SAW BLADES (OSCILLATING SAW BLADES)

Sagittale Sägeblätter (oszillierende Sägeblätter)

Lames de scie sagittale (lames oscillantes)

Hojas de sierra sagitales (hojas de sierra oscilantes)

Lame per sega sagittale (lame per sega oscillante)



<b>GC648R</b>	50 mm	10 mm	0.5 mm	0.8 mm
<b>GC649R</b>	50 mm	15 mm	0.5 mm	0.8 mm
<b>GC650R</b>	50 mm	20 mm	0.7 mm	0.9 mm
<b>GC651R</b>	50 mm	25 mm	0.7 mm	0.9 mm
<b>GC652R</b>	50 mm	30 mm	0.7 mm	0.9 mm

»GB129



GC648R

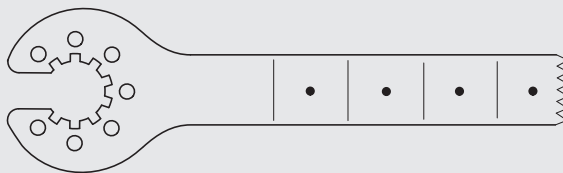

GC649R

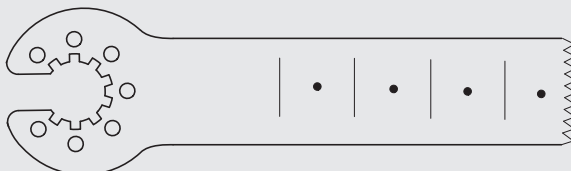

GC650R

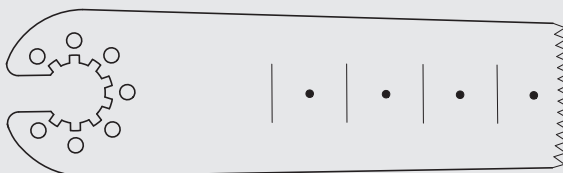

GC651R

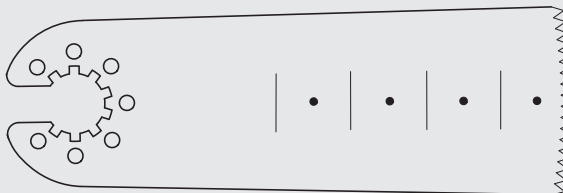

GC652R

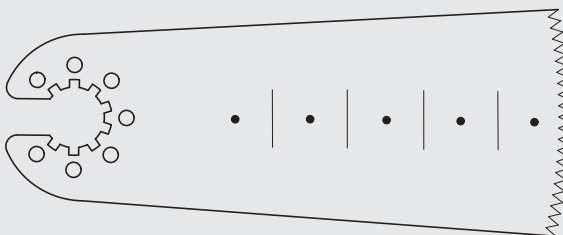

## RECIPROCATING SAW BLADES

Stichsägeblätter

Lames de scie alternative

Hojas de sierra de punta

Lame per sega reciprocant



GA737

GA837

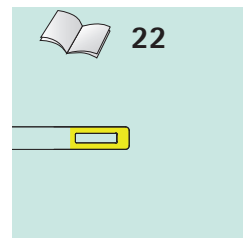

GA732

GA832

GB892R

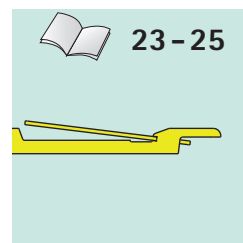

GA334

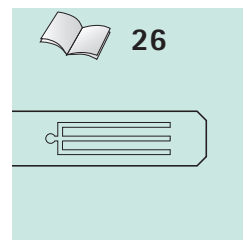

GD305

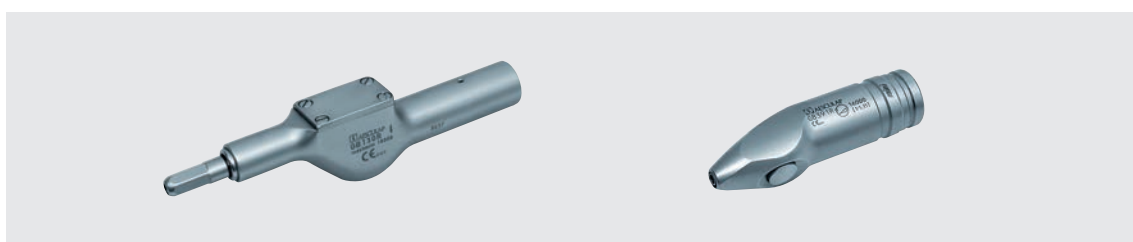
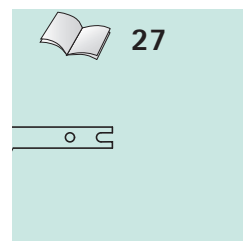

GB130R

GB391R

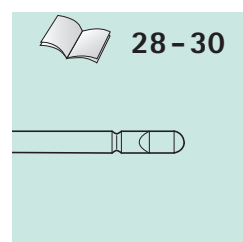

# AESULAP<sup>®</sup> BURRS & BLADES

## RECIPROCATING SAW BLADES

Stichsägeblätter

Lames de scie alternative

Hojas de sierra de punta

Lame per sega reciprocant



GP541R	16 mm	0.3 mm	0.3 mm		
GP542R	13 mm	0.3 mm	0.3 mm		
GP543R	20 mm	0.3 mm	0.3 mm		
GP544R	13 mm	0.3 mm	0.3 mm		
GP545R	20 mm	0.3 mm	0.3 mm		

» GA737, GA837



GP541R 

GP542R 

GP543R 

GP544R 

GP545R 

1 sterile



GP551R	84 mm	25 mm	0.40 mm	0.60 mm
GP561R	104 mm	25 mm	0.40 mm	0.60 mm
GP552R	85 mm	27 mm	0.25 mm	0.35 mm
GP553R	85 mm	27 mm	0.40 mm	0.60 mm
GP562R	105 mm	27 mm	0.25 mm	0.35 mm
GP563R	105 mm	27 mm	0.40 mm	0.60 mm
GP554R	91 mm	33 mm	0.40 mm	0.60 mm
GP564R	111 mm	33 mm	0.40 mm	0.60 mm

» GA732, GA832, GB892R



GP551R

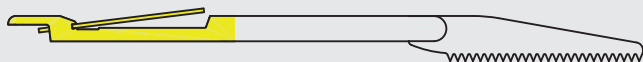

GP561R

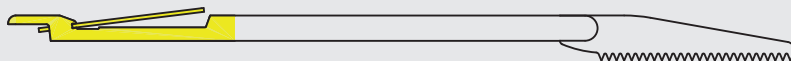

GP552R

GP553R

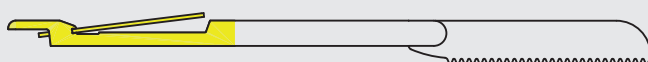

GP562R

GP563R

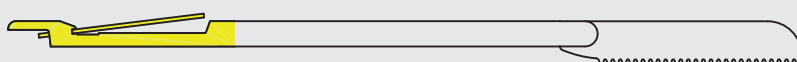

GP554R

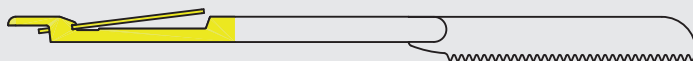

GP564R

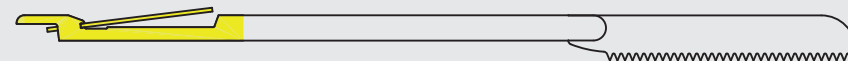

# AESCULAP® BURRS & BLADES

## RECIPROCATING SAW BLADES

Stichsägeblätter

Lames de scie alternative

Hojas de sierra de punta

Lame per sega reciprocant

							
<b>GP565R</b>		115 mm	37 mm	0.4 mm	0.6 mm		<b>» GA732, GA832, GB892R</b>   
<b>GP550R</b>		73 mm	15 mm	0.4 mm	0.6 mm		
<b>GP575R</b>		79 mm	17 mm	0.4 mm	0.6 mm	4 mm	
<b>GP576R</b>		86 mm	24 mm	0.4 mm	0.6 mm	6 mm	
							
<b>GC615R</b>		23 mm	0.25 mm	0.35 mm			
<b>GC633R</b>		23 mm	0.25 mm	0.35 mm			
							
<b>GP559R</b>		70 mm					
<b>GP569R</b>		90 mm					

GP565R

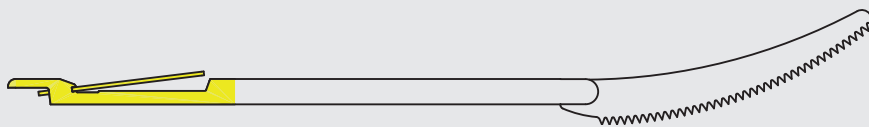

GP550R

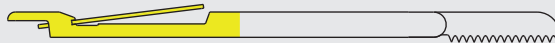

GP575R

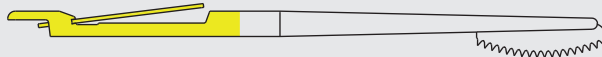

GP576R

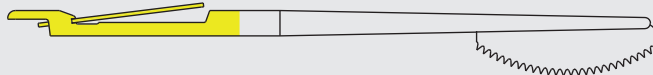

GC615R



GC633R



GP559R

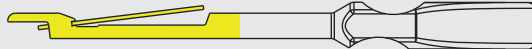

GP569R

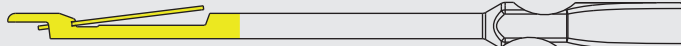



1 sterile



GP557R

75 mm

10.0 mm

5 mm

GP558R

75 mm

12.5 mm

7 mm

GP567R

93 mm

10.5 mm

5 mm

» GA732, GA832, GB892R



GP557R

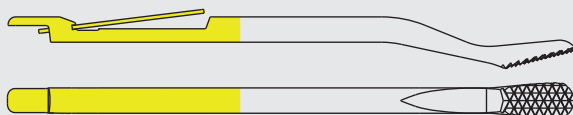

GP558R

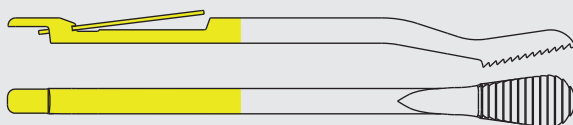

GP567R

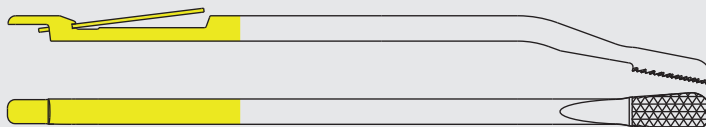

# AESCU LAP<sup>®</sup> BURRS & BLADES







## RECIPROCATING SAW BLADES

Stichsägeblätter

Lames de scie alternative

Hojas de sierra de punta

Lame per sega reciprocant

	 sterile					
<b>GC766R</b>		43 mm		0.7 mm	0.9 mm	<b>» GA334, GA674</b> 
<b>GC767R</b>		60 mm		0.7 mm	0.9 mm	
<b>GC768R</b>		75 mm		0.7 mm	0.9 mm	
<b>GC769R</b>		75 mm		1.0 mm	1.2 mm	
<b>GC770R</b>		75 mm	12 mm	0.7 mm	0.9 mm	
<b>GC771R</b>		75 mm	12 mm	1.0 mm	1.2 mm	

**GC766R**

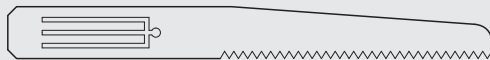

**GC767R**

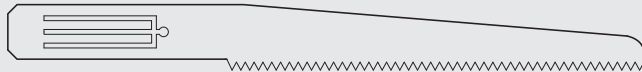



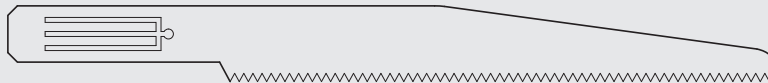

**GC768R -  
GC769R**

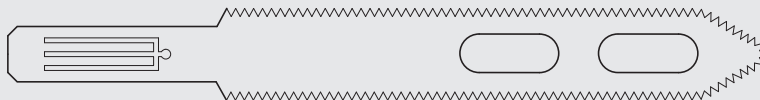

**GC770R -  
GC771R**



	 sterile				
<b>GC761R</b>		34 mm	0.7 mm	1.1 mm	<b>» GA334 + GB436R</b> <b>GA674 + GB436R</b>



**GC761R**

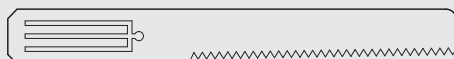



<b>GD320R</b>	13 mm	0.3 mm	0.3 mm		<b>» GD305</b> 
<b>GD321R</b>	20 mm	0.3 mm	0.3 mm		
<b>GD322R</b>	13 mm	0.3 mm	0.3 mm		
<b>GD323R</b>	13 mm	0.3 mm	0.3 mm		



# AESCULAP® BURRS & BLADES

## RECIPROCATING SAW BLADES

Stichsägeblätter

Lames de scie alternative

Hojas de sierra de punta

Lame per sega reciprocant



<b>GC912R</b>	84 mm	25 mm	0.40 mm	0.60 mm		<b>»GB130R</b>
<b>GC655R</b>	104 mm	25 mm	0.40 mm	0.60 mm		<b>»GB391R</b>
<b>GC906R</b>	85 mm	27 mm	0.25 mm	0.35 mm		
<b>GC907R</b>	85 mm	27 mm	0.40 mm	0.60 mm		
<b>GC656R</b>	105 mm	27 mm	0.25 mm	0.35 mm		
<b>GC657R</b>	105 mm	27 mm	0.40 mm	0.60 mm		
<b>GC909R</b>	91 mm	33 mm	0.40 mm	0.60 mm		
<b>GC658R</b>	111 mm	33 mm	0.40 mm	0.60 mm		



**GC912R**



**GC655R**

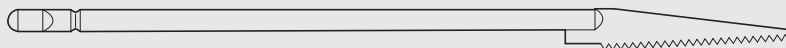

**GC906R -  
GC907R**

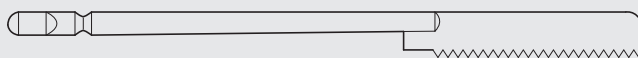

**GC656R -  
GC657R**

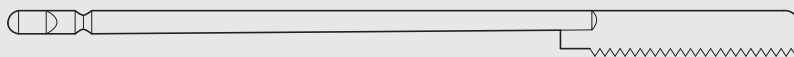

**GC909R**

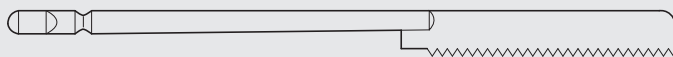

**GC658R**

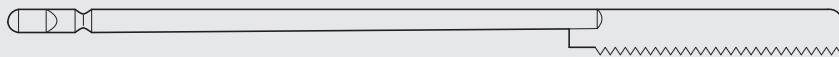



1 sterile



GC905R

73 mm

15 mm

0.4 mm

0.6 mm

» GB130R

» GB391R

10 sterile



GC615R

23 mm

0.25 mm

0.35 mm

GC633R

23 mm

0.25 mm

0.35 mm



1 sterile



GC927R

70 mm

GC654R

90 mm

GC905R

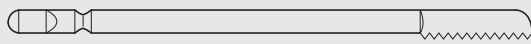

GC615R

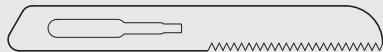

GC633R



GC927R

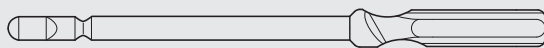

GC654R

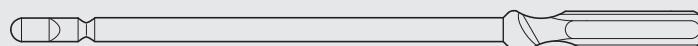

# AESCULAP® BURRS & BLADES













## RECIPROCATING SAW BLADES

Stichsägeblätter

Lames de scie alternative

Hojas de sierra de punta

Lame per sega reciprocant

	 sterile							
<b>GC915R</b>		79 mm	17 mm	0.4 mm	0.6 mm	4 mm		
<b>GC916R</b>		86 mm	24 mm	0.4 mm	0.6 mm	6 mm		
<b>GC923R</b>		88 mm	33 mm	0.4 mm	0.6 mm			
<b>GC925R</b>		88 mm	33 mm	0.4 mm	0.6 mm	5 mm		
<b>GC926R</b>		88 mm	33 mm	0.4 mm	0.6 mm	5 mm		
	 sterile							
<b>GC919R</b>		75.5 mm	10 mm	5 mm				
<b>GC921R</b>		75.5 mm	12.5 mm	7 mm				

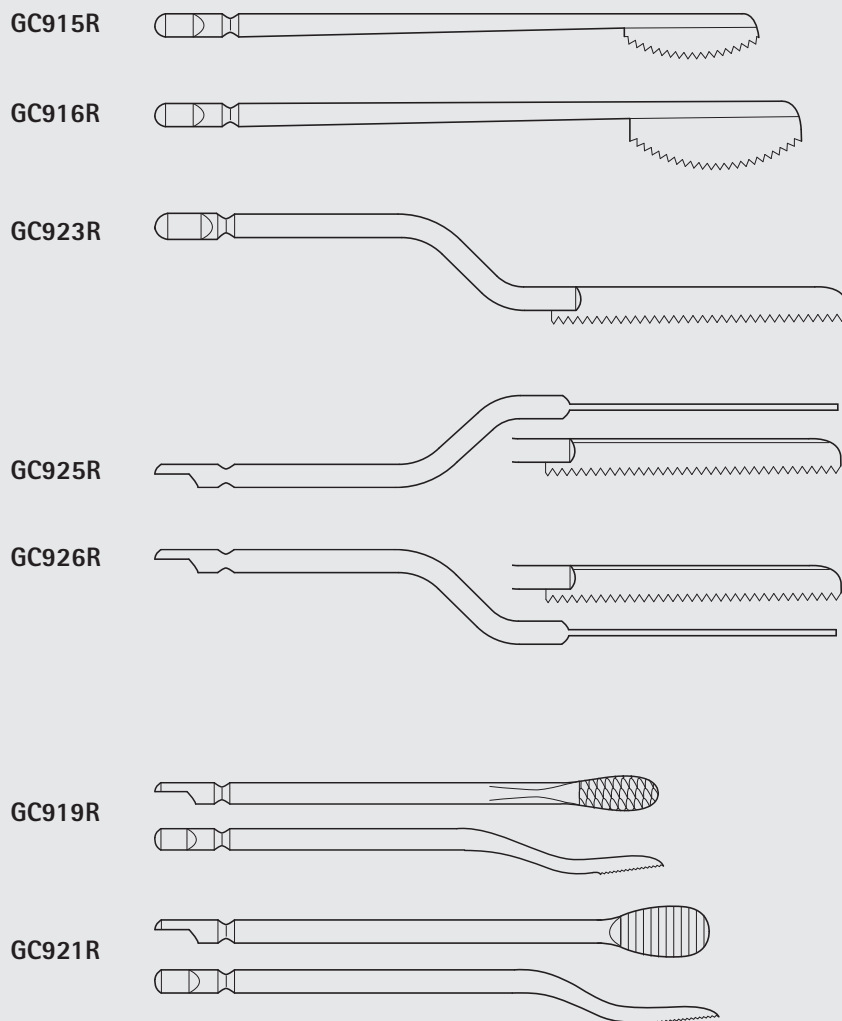

## TRANSVERSAL SAW BLADES

Transversalsägeblätter  
Lames de scie transversale  
Hojas de sierra transversal  
Lame per sega trasversale

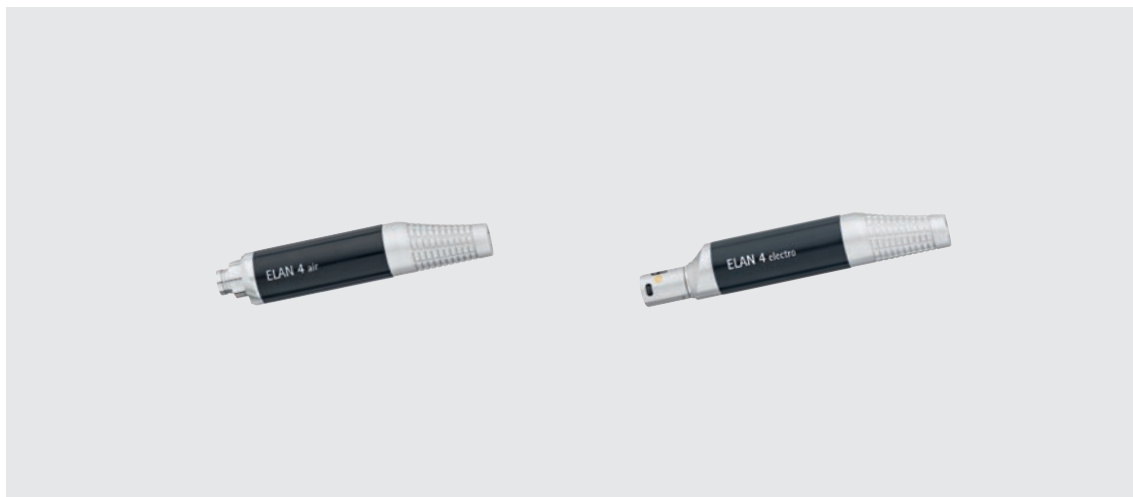

**GA733**

**GA833**

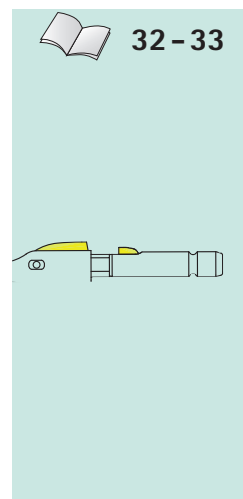

**GB392R**

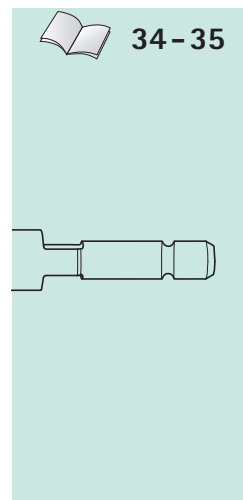

**GB128R**

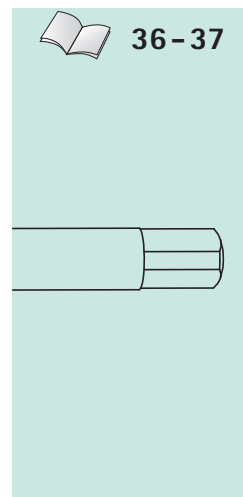

# AESCULAP® BURRS & BLADES

## TRANSVERSAL SAW BLADES

Transversalsägeblätter

Lames de scie transversale

Hojas de sierra transversal

Lame per sega trasversale



GP580R	65 mm	S			
GP582R	65 mm	M			
GP586R	95 mm	M			
GP590R	30 mm	L			

» GA733, GA833



GP580R



GP582R



GP586R

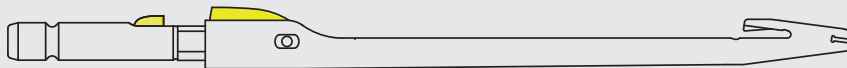

GP590R

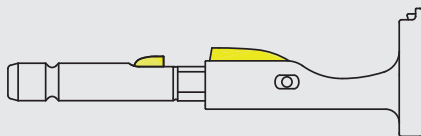



1 sterile



GP581R	8 mm	4 mm	0.3 mm	0.4 mm	S
GP583R	10 mm	10 mm	0.5 mm	0.7 mm	M
GP584R	15 mm	12 mm	0.5 mm	0.7 mm	M
GP587R	11 mm	7 mm	0.5 mm	0.7 mm	M
GP588R	11 mm	12 mm	0.5 mm	0.7 mm	M
GP591R	8 mm	25 mm	0.5 mm	0.7 mm	L
GP594R	8 mm	12 mm	0.5 mm	0.7 mm	L
GP595R	14 mm	12 mm	0.5 mm	0.7 mm	L
GP598R	37 mm	25 mm	0.5 mm	0.7 mm	L

» GA733, GA833



GP581R



GP591R



GP583R

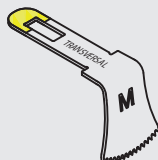

GP594R

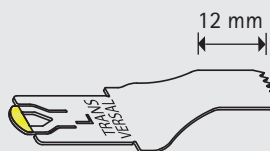

GP584R

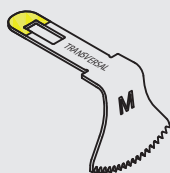

GP595R

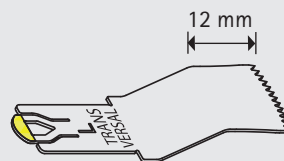

GP587R

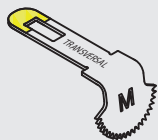

GP598R

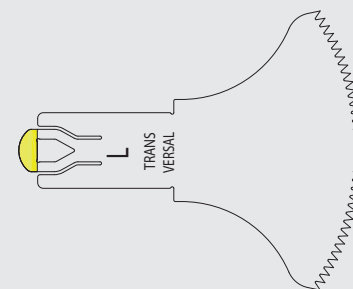

GP588R

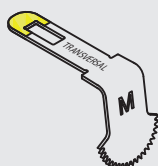

# AESCULAP® BURRS & BLADES







## TRANSVERSAL SAW BLADES

Transversalsägeblätter

Lames de scie transversale

Hojas de sierra transversal

Lame per sega trasversale

	 sterile						
<b>GC261R</b>		65 mm	7.5 mm	4 mm	0.3 mm	0.4 mm	
<b>GC263R</b>		60 mm	10.5 mm	8 mm	0.5 mm	0.6 mm	
<b>GC265R</b>		60 mm	16.0 mm	12 mm	0.5 mm	0.5 mm	
<b>GC267R</b>		95 mm	11.0 mm	7 mm	0.4 mm	0.6 mm	
<b>GC269R</b>		95 mm	11.0 mm	12 mm	0.4 mm	0.6 mm	

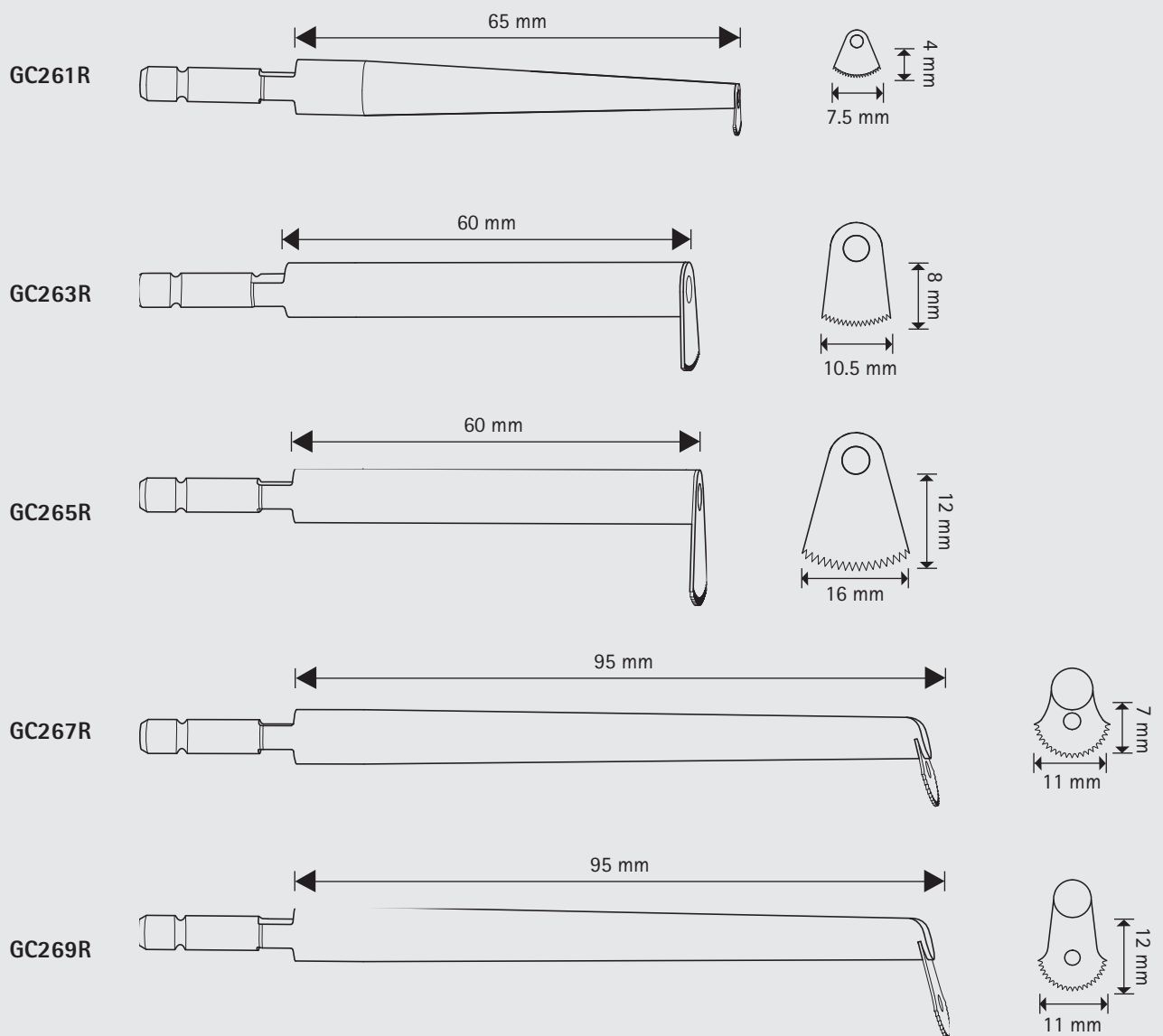

1 sterile



» GB392R



GC271R	8.0 mm	25 mm	0.5 mm	0.7 mm
GC273R	7.3 mm	30 mm	0.6 mm	0.7 mm
GC277R	8.0 mm	11 mm	0.5 mm	0.7 mm
GC279R	16.0 mm	11 mm	0.5 mm	0.7 mm

GC271R

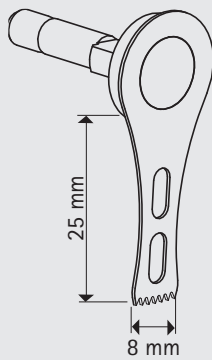

GC277R

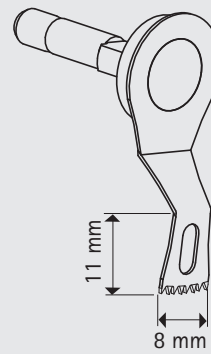

GC273R

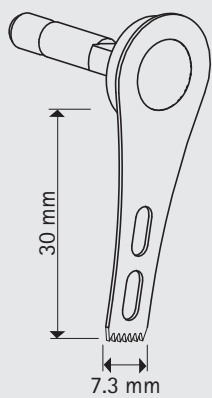

GC279R

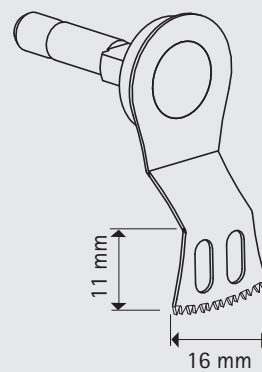

# AESCALAP<sup>®</sup> BURRS & BLADES







## TRANSVERSAL SAW BLADES

Transversalsägeblätter

Lames de scie transversale

Hojas de sierra transversal

Lame per sega trasversale

							
<b>GC584R</b>		65 mm	7.5 mm	4 mm	0.25 mm	0.4 mm	<b>»GB128R</b>
<b>GC583R</b>		60 mm	10.5 mm	8 mm	0.50 mm	0.6 mm	
<b>GC585R</b>		60 mm	16.0 mm	12 mm	0.50 mm	0.5 mm	
<b>GC587R</b>		95 mm	11.0 mm	7 mm	0.40 mm	0.6 mm	
<b>GC586R</b>		95 mm	11.0 mm	12 mm	0.40 mm	0.6 mm	

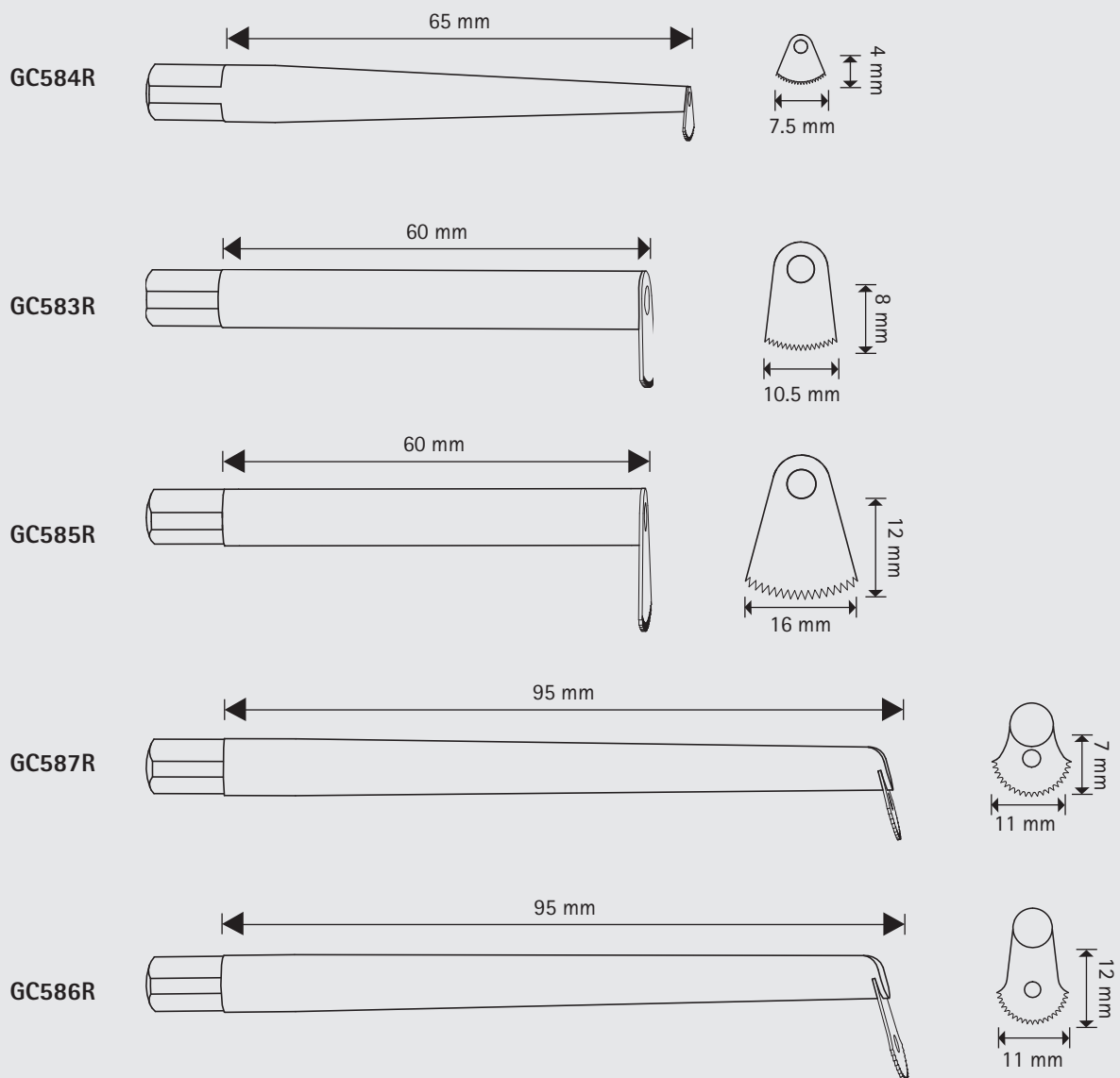



<b>GC570R</b>	9/40 mm	15 mm	0.5 mm	0.8 mm
<b>GC575R</b>	8 mm	25 mm	0.5 mm	0.7 mm
<b>GC576R</b>	7.3 mm	30 mm	0.6 mm	0.7 mm
<b>GC578R</b>	8 mm	11 mm	0.5 mm	0.7 mm
<b>GC580R</b>	16 mm	11 mm	0.5 mm	0.7 mm

» **GB128R**



**GC570R**

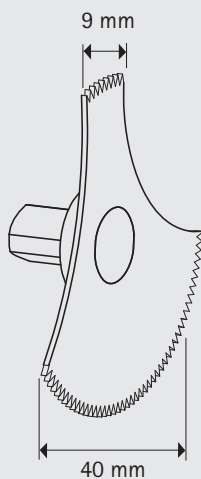

**GC576R**

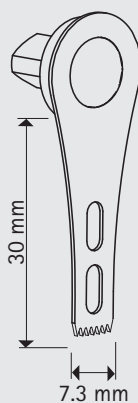

**GC580R**

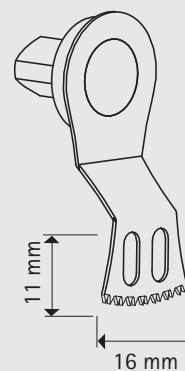

**GC575R**

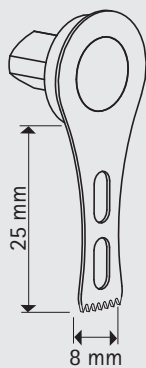

**GC578R**

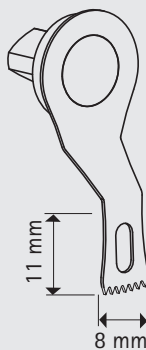

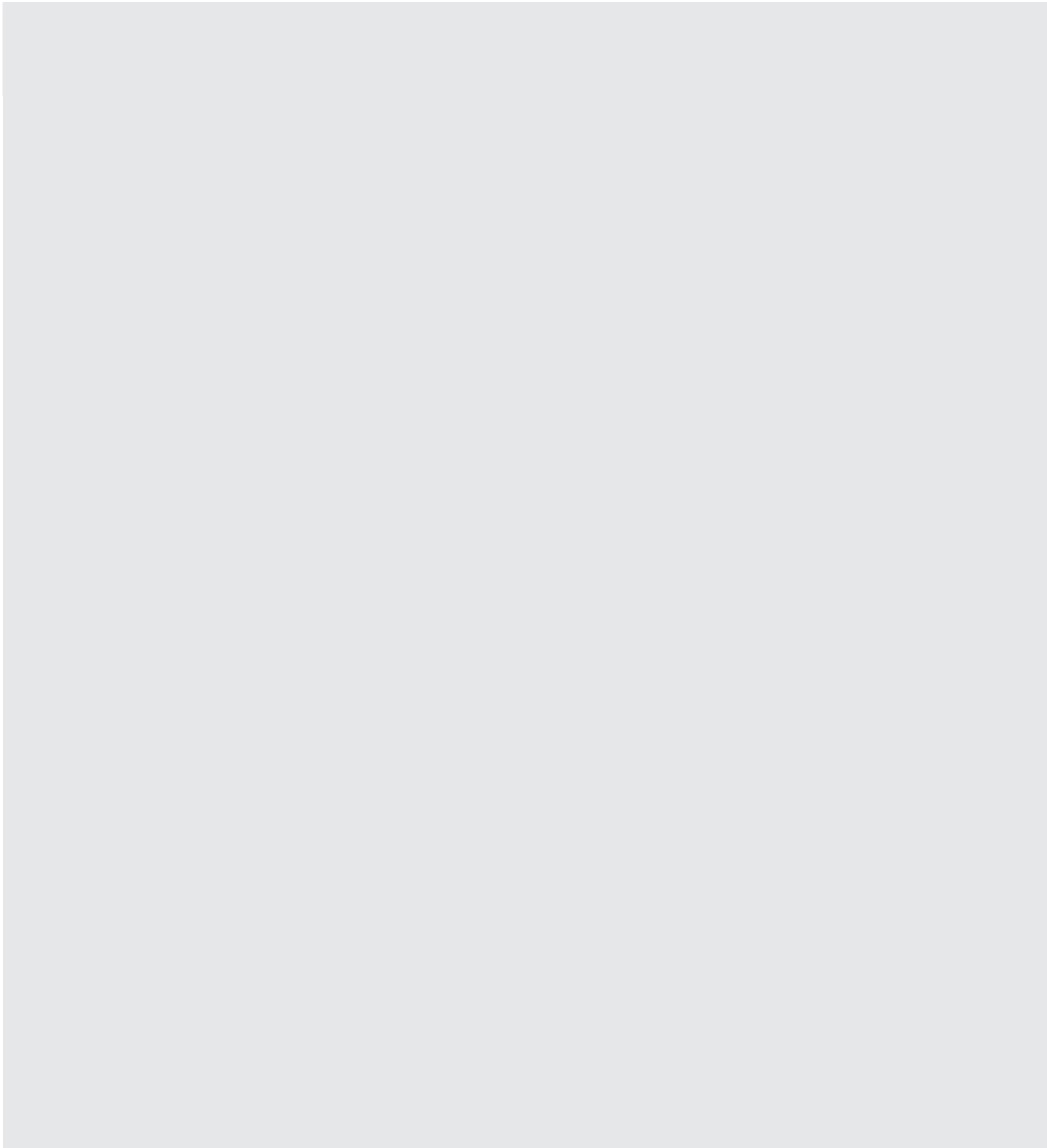

# AESCULAP® BURRS & BLADES

## ELAN 4 BURRS

ELAN 4 Fräser  
 Fraises ELAN 4  
 Fresa ELAN 4  
 Fresa ELAN 4



**GA761 - GA764**



**GA861 - GA864**



I



**GA765 - GA769**



**GA865 - GA869**



II



**GA749**



**GA849**

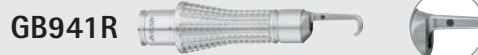

II

# AESCU LAP® BURRS & BLADES









## ELAN 4 BURRS – 1-RING





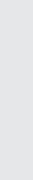
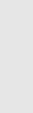
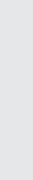
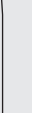



ELAN 4 Fräser – 1-Ring





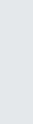
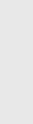
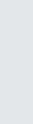

Fraises ELAN 4 – 1 anneau





Fresa ELAN 4 – 1 anillos

Fresa ELAN 4 – 1 anelli

Ø	0.6 mm	0.8 mm	1.0 mm	1.0 mm	1.4 mm	1.4 mm	1.8 mm	1.8 mm	2.3 mm	2.3 mm		
												sterile
I	GP111R	GP112R	GP113R	GP114R	GP115R	GP116R	GP117R	GP118R	GP120R	GP121R		Rosen

Ø	2.7 mm	2.7 mm	3.0 mm	3.5 mm	4.0 mm	4.5 mm	5.0 mm	6.0 mm				
												sterile
I	GP122R	GP123R	GP124R	GP125R	GP126R	GP127R	GP128R	GP129R				Rosen



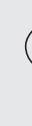

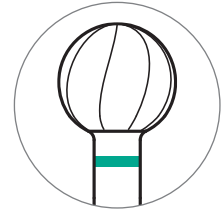

Ø	3.0 mm	4.0 mm	5.0 mm	6.0 mm	
Soft cut					
					
I	GP133R	GP134R	GP135R	GP136R	Rosen

Ø	4.0 mm	5.0 mm	6.0 mm	7.0 mm
				
I	GP184R	GP185R	GP186R	GP187R

Twin-Cut burr  
Twin-Cut Fräser  
Fraise Twin-Cut  
Fresa Twin-Cut  
Fresa Twin-Cut





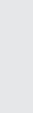
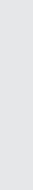
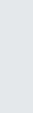
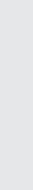





Ø	0.6 mm	0.8 mm	1.0 mm	1.0 mm	1.4 mm	1.4 mm	1.8 mm	1.8 mm	2.3 mm	2.3 mm		
												
I	GP141R	GP142R	GP143R	GP144R	GP145R	GP146R	GP147R	GP148R	GP149R	GP150R		

 sterile

Diamond burr  
 Diamantfräser  
 Fraise à diamant  
 Fresa diamante  
 Fresa a diamante

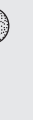
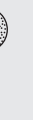
Ø	2.7 mm	2.7 mm	3.0 mm	3.5 mm	4.0 mm	4.5 mm	5.0 mm	6.0 mm				
												
I	GP151R	GP152R	GP153R	GP154R	GP155R	GP156R	GP157R	GP158R				

 sterile

Diamond burr  
 Diamantfräser  
 Fraise à diamant  
 Fresa diamante  
 Fresa a diamante



# AESULAP<sup>®</sup> BURRS & BLADES











## ELAN 4 BURRS – 1-RING







ELAN 4 Fräser – 1-Ring

Fraises ELAN 4 – 1 anneau

Fresa ELAN 4 – 1 anillos

Fresa ELAN 4 – 1 anelli

Ø	2.0 mm	2.0 mm	2.3 mm	2.3 mm	3.0 mm	3.0 mm	4.0 mm	5.0 mm	6.0 mm			
												
I	GP161R	GP162R	GP163R	GP164R	GP165R	GP166R	GP168R	GP169R	GP170R			
												 sterile Diamond burr coarse, Diamantfräser grob, Fraise diamantée rugueuse, Fresa diamantada de grano grueso, Frese a diamante grosso

Ø	3.0 mm	4.0 mm	5.0 mm	6.0 mm	7.0 mm							
												
I	GP173R	GP174R	GP175R	GP176R	GP177R							
												 sterile Diamond burr extra coarse, Diamantfräser extra grob, Fraise diamantée très rugueuse, Fresa diamantada de grano extra grueso, Frese a diamante extra-grosse

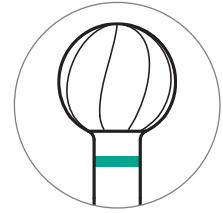

Ø	1.5 mm	2.0 mm	2.5 mm	3.0 mm	3.0 mm
US Type					
I	GP201R	GP202R	GP203R	GP204R	GP205R

sterile

Neuro cutter  
Olivenfräser  
Fraise à olive  
Fresa oliva  
Fresa ad oliva

Ø	2.0 mm	2.5 mm	3.0 mm
AESCLAP® Type			
I	GP208R	GP209R	GP210R

sterile

Neuro cutter  
Olivenfräser  
Fraise à olive  
Fresa oliva  
Fresa ad oliva

Ø	1.5 mm	1.5 mm	2.0 mm	2.0 mm	2.5 mm	2.5 mm	3.0 mm	3.0 mm	4.0 mm	4.0 mm
I	GP211R	GP212R	GP213R	GP214R	GP215R	GP216R	GP217R	GP218R	GP219R	GP220R

sterile

Neuro cutter diamond  
Olivenfräser diamantiert  
Fraise à olive diamantée  
Fresa oliva diamantada  
Fresa ad oliva diamant

Ø	4.0 mm	5.0 mm	6.0 mm
Standard			
I	GP224R	GP225R	GP226R

sterile

Barrel burr  
Walzenfräser  
Fraise cylindrique  
Fresa cilíndrica  
Fresa tangenziale

Ø	4.0 mm	5.0 mm	6.0 mm
Soft cut			
I	GP228R	GP229R	GP230R

sterile

Barrel burr  
Walzenfräser  
Fraise cylindrique  
Fresa cilíndrica  
Fresa tangenziale

Ø	4.0 mm	5.0 mm	6.0 mm
I	GP234R	GP235R	GP236R

sterile

Cone burr  
Kegelfräser  
Fraise conique  
Fresa cónica  
Fresa conica

# AESCULAP® BURRS & BLADES

## ELAN 4 BURRS – 1-RING

ELAN 4 Fräser – 1-Ring

Fraises ELAN 4 – 1 anneau

Fresa ELAN 4 – 1 anillos

Fresa ELAN 4 – 1 anelli

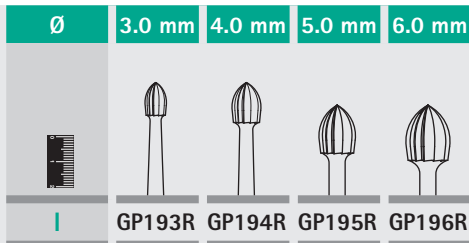
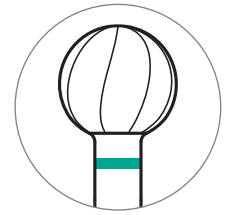

Acorn burr  
Flammenfräser  
Fraise flamme  
Fresa flama  
Fresa di flamma

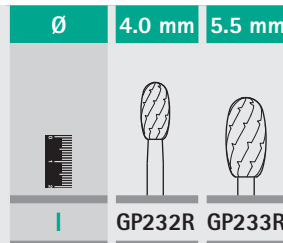

Oval burr  
Ellipsenfräser  
Fraise elliptique  
Fresa elíptica  
Fresa elíptica

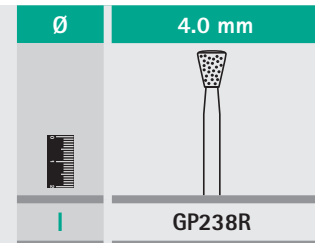

Reverse taper burr coarse diamond  
Osteophytenfräser  
Fraise pour ostéophytes  
Fresa per resezione osteofiti  
Fresa de diamante para osteofitos

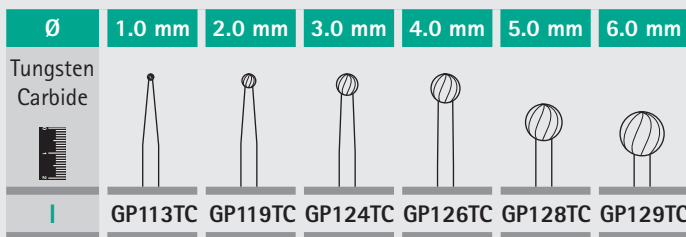

Rosen

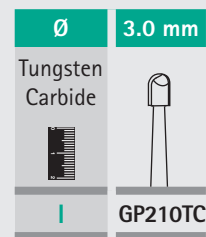

Neuro cutter  
Olivenfräser  
Fraise à olive  
Fresa oliva  
Fresa ad oliva

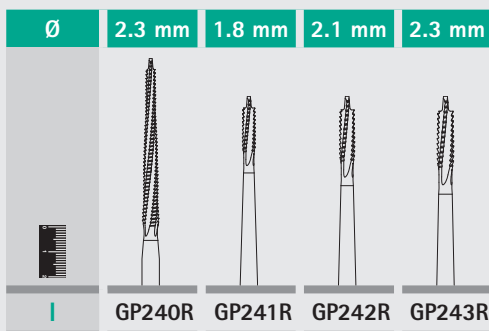

Lindemann

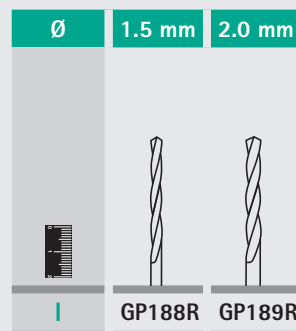

Twist drill  
Spiralbohrer  
Fraise spirale  
Broca espiral  
Punta elicoidale

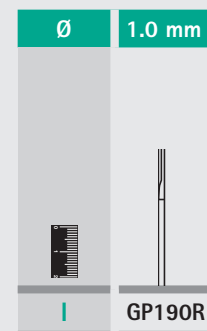

Pin cutter  
Pinfräser  
Fraise pointue  
Fresa punta  
Fresa puntuale

## ELAN 4 BURRS – 2-RING

ELAN 4 Fräser – 2-Ring  
 Fraises ELAN 4 – 2 anneaux  
 Fresa ELAN 4 – 2 anillos  
 Fresa ELAN 4 – 2 anelli

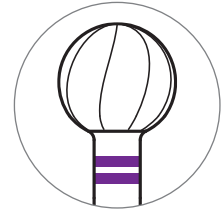

Ø	2.3 mm	3.0 mm	3.5 mm	4.0 mm	4.5 mm	5.0 mm	6.0 mm	7.0 mm	8.0 mm			
												sterile
II	GP301R	GP302R	GP303R	GP304R	GP305R	GP306R	GP307R	GP308R	GP309R			Rosen

Ø	2.3 mm	3.0 mm	3.5 mm	4.0 mm	4.5 mm	5.0 mm	6.0 mm					
												sterile
II	GP311R	GP312R	GP313R	GP314R	GP315R	GP316R	GP317R					Diamond burr Diamantfräser Fraise à diamant Fresa diamante Fresa a diamante

Ø	2.3 mm	3.0 mm	4.0 mm	5.0 mm	6.0 mm							
												sterile
II	GP321R	GP322R	GP323R	GP324R	GP325R							Diamond burr coarse, Diamantfräser grob, Fraise diamantée rugueuse, Fresa diamantada de grano grueso, Frese a diamante grosse

Ø	4.0 mm	5.0 mm	6.0 mm									
												sterile
II	GP328R	GP329R	GP330R									Diamond burr extra coarse, Diamantfräser extra grob, Fraise dia- mantée très rugueuse, Fresa diamantada de grano extra grueso, Frese a diamante extra-grosse

ELAN 4

# AESCULAP® BURRS & BLADES

## ELAN 4 BURRS – 2-RING

ELAN 4 Fräser – 2-Ring

Fraises ELAN 4 – 2 anneaux

Fresa ELAN 4 – 2 anillos

Fresa ELAN 4 – 2 anelli

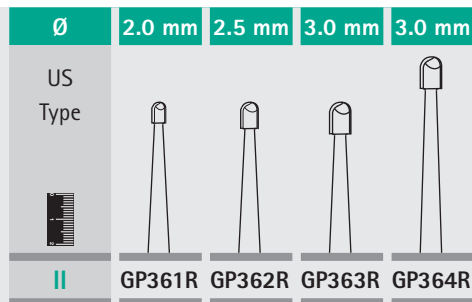

Neuro cutter  
Olivenfräser  
Fraise à olive  
Fresa oliva  
Fresa ad oliva

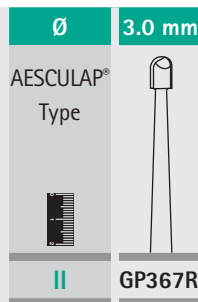

Neuro cutter  
Olivenfräser  
Fraise à olive  
Fresa oliva  
Fresa ad oliva

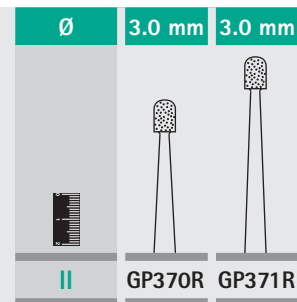

Neuro cutter diamond  
Olivenfräser diamantiert  
Fraise à olive diamantée  
Fresa oliva diamantada  
Fresa ad oliva diamant

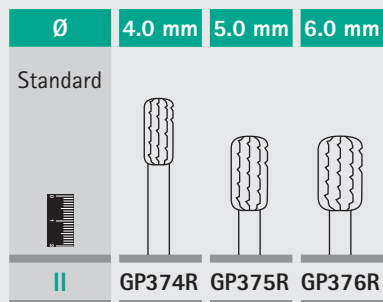

Barrel burr  
Walzenfräser  
Fraise cylindrique  
Fresa cilíndrica  
Fresa tangenziale

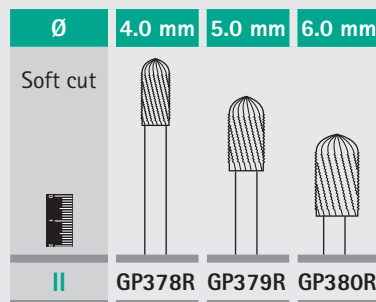

Barrel burr  
Walzenfräser  
Fraise cylindrique  
Fresa cilíndrica  
Fresa tangenziale

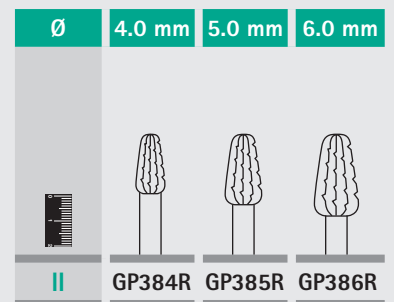

Cone burr  
Kegelfräser  
Fraise conique  
Fresa cónica  
Fresa conica

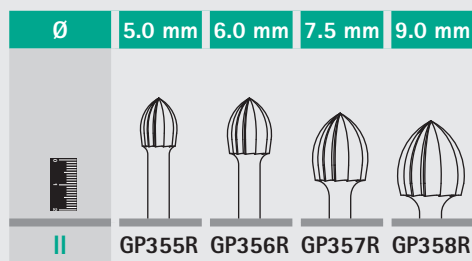

Acorn burr  
Flammenfräser  
Fraise flamme  
Fresa flama  
Fresa di flamma

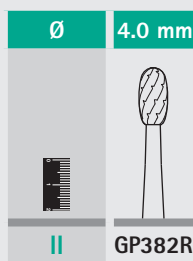

Oval burr  
Ellipsenfräser  
Fraise elliptique  
Fresa elíptica  
Fresa elíptica

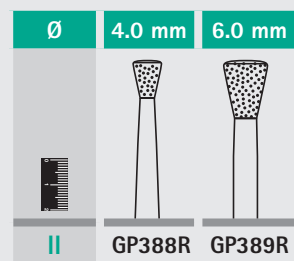

Reverse taper burr coarse diamond  
Osteophytenfräser  
Fraise pour ostéophytes  
Fresa per resezione osteofiti  
Fresa de diamante para osteofitos

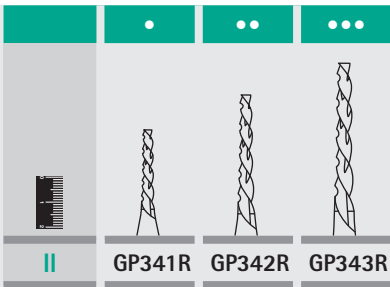
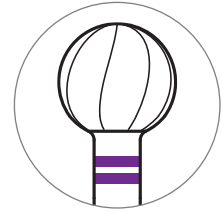

1 sterile

Craniotome cutter – spiral type  
 Kraniotomfräser – spiralgig  
 Fraise craniotome – en spirale  
 Fresa cranéotomo – helicoidal  
 Fresa di craniotomo – a spirale

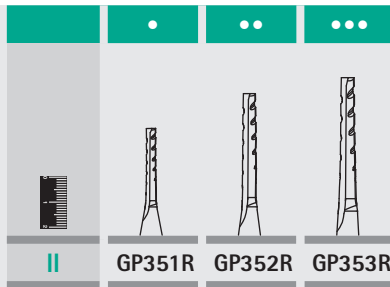

1 sterile

Craniotome cutter – straight type  
 Kraniotomfräser – geradverzahnt  
 Fraise craniotome – dents droites  
 Fresa cranéotomo – dientes rectos  
 Fresa di craniotomo – denti dritti

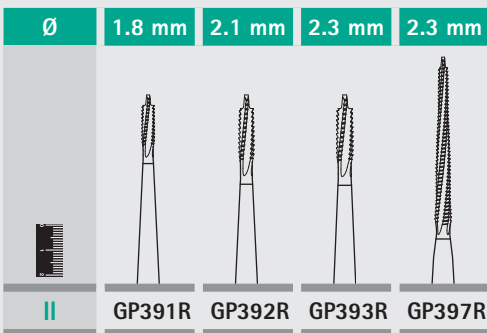

1 sterile

Lindemann

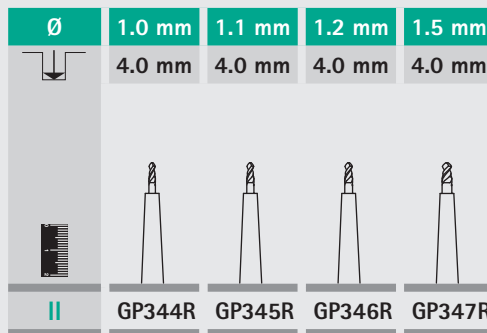

1 sterile

Twist drill  
 Spiralbohrer  
 Fraise spirale  
 Broca espiral  
 Punta elicoidale

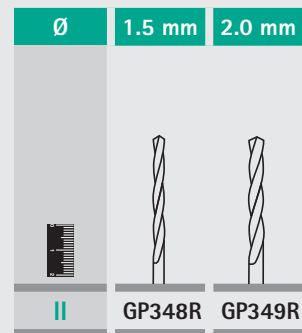

1 sterile

Twist drill  
 Spiralbohrer  
 Fraise spirale  
 Broca espiral  
 Punta elicoidale

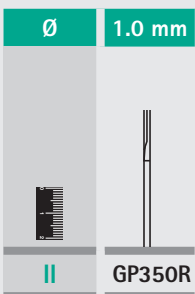

1 sterile

Pin cutter  
 Pinfräser  
 Fraise pointue  
 Fresa punta  
 Fresa puntuale

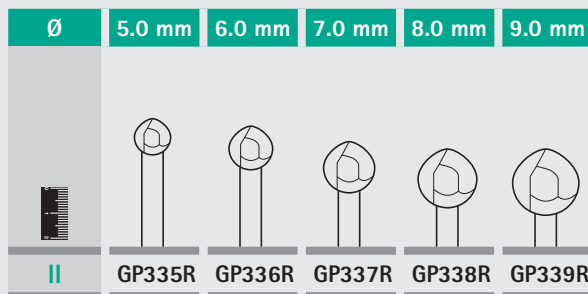

1 sterile

Twin-Cut burr  
 Twin-Cut Fräser  
 Fraise Twin-Cut  
 Fresa Twin-Cut  
 Fresa Twin-Cut

# AESCULAP® BURRS & BLADES

## ELAN 4 BURRS – 2-RING

ELAN 4 Fräser – 2-Ring

Fraises ELAN 4 – 2 anneaux

Fresa ELAN 4 – 2 anillos

Fresa ELAN 4 – 2 anelli

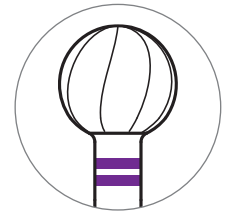

### Tungsten Carbide Burrs

Ø	2.3 mm	3.0 mm	4.0 mm	5.0 mm	6.0 mm	7.0 mm	8.0 mm
II	GP301TC	GP302TC	GP304TC	GP306TC	GP307TC	GP308TC	GP309TC

sterile

Rosen

Ø	1.2 mm	1.6 mm
II	GP395TC	GP396TC

sterile

Taper burr  
Konusfräser  
Fraise conique  
Fresa cónica  
Fresa conica

Ø	3.0 mm
II	GP367TC

sterile

Neuro cutter  
Olivenfräser  
Fraise à olive  
Fresa oliva  
Fresa ad oliva

### Burrs for metal dissection

Ø	2.3 mm
II (2)	GP399TC-SU

sterile

Side cutter  
Zylinderfräser  
Fraise cylindrique  
Fresa cilíndrica  
Fresa cilíndrica

Ø	25 mm
II (2)	GP398SU

sterile

Diamond disc  
Diamant-Trennscheibe  
Disque cou pant diamant  
Disco cortante de diamante  
Disco tagliante diamante



## ELAN 4 BURRS – MIS

ELAN 4 Fräser – MIS

Fraises ELAN 4 – MIS

Fresa ELAN 4 – MIS

Fresa ELAN 4 – MIS

**GA760**



**GA860**



ELAN 4



**GB920R**

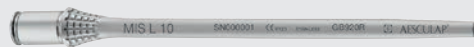

**GB921R**



**GB922R**



**L10**

**GB925R**

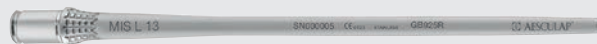

**GB926R**



**GB927R**





**L13**

# AESCU LAP<sup>®</sup> BURRS & BLADES



## ELAN 4 BURRS – MIS

ELAN 4 Fräser – MIS  
 Fraises ELAN 4 – MIS  
 Fresa ELAN 4 – MIS  
 Fresa ELAN 4 – MIS

Ø	3.0 mm	4.0 mm		
				
L10 (2)	GP422SU	GP423SU		
L13 (2)	GP442SU	GP443SU		







Rosen

Ø	2.0 mm	3.0 mm		
				
L10 (2)	GP420SU	GP421SU		
L13 (2)	GP440SU	GP441SU		







Neuro cutter  
 Olivenfräser  
 Fraise à olive  
 Fresa oliva  
 Fresa ad oliva

Ø	3.0 mm	4.0 mm	5.0 mm	
				
L10 (2)	GP432SU	GP433SU	GP434SU	
L13 (2)	GP452SU	GP453SU	GP454SU	







Diamond burr  
 Diamantfräser  
 Fraise diamantée  
 Fresa diamantada  
 Frese a diamante

Ø	3.0 mm	4.0 mm	5.0 mm	
				
L10 (2)	GP435SU	GP436SU	GP437SU	
L13 (2)	GP455SU	GP456SU	GP457SU	







Diamond burr extra coarse  
 Diamantfräser extra grob  
 Fraise diamantée très ruguese  
 Fresa diamantada de grano extra grueso  
 Frese a diamante extra-grosse

Ø	2.0 mm	3.0 mm	4.0 mm	5.0 mm
				
L10 (2)	GP424SU	GP425SU	GP426SU	GP427SU
L13 (2)	GP444SU	GP445SU	GP446SU	GP447SU



Neuro cutter diamond  
 Olivenfräser diamantiert  
 Fraise à olive diamantée  
 Fresa oliva diamantada  
 Fresa ad oliva diamante

















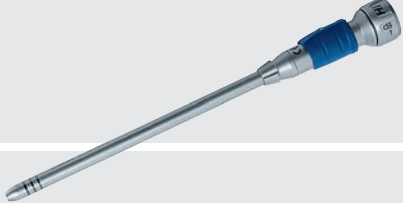

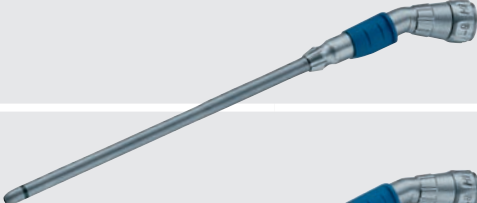

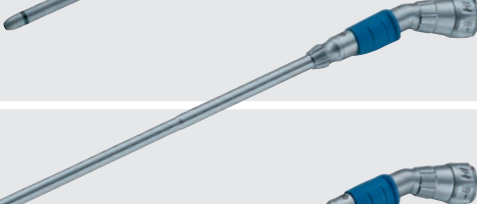

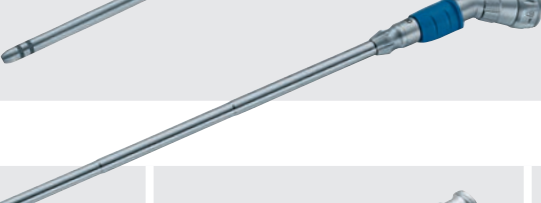





Ø	3.0 mm	4.0 mm	5.0 mm	
				
L10 (2)	GP428SU	GP429SU	GP430SU	
L13 (2)	GP448SU	GP449SU	GP450SU	



Neuro cutter diamond extra coarse  
 Olivenfräser diamantiert extra grob  
 Fraise à olive diamantée très ruguese  
 Fresa oliva diamantada de grano extra grueso  
 Fresa ad oliva diamante extra-grosse

# Hi-Line XS BURRS

Hi-Line XS Fräser  
 Fraises Hi-Line XS  
 Fresa Hi-Line XS  
 Fresa Hi-Line XS

<b>GB751R</b> 	<b>GB756R</b> 	 <b>I</b>	
<b>GB752R</b> 	<b>GB757R</b> 	 <b>II</b>	
<b>GB753R</b> 	<b>GB758R</b> 	 <b>III</b>	
<b>GB771R</b> 		 <b>XLI</b>	
<b>GB772R</b> 		 <b>XLII</b>	
<b>GB773R</b> 		 <b>XLIII</b>	
<b>GB740R</b> 	<b>GB744R</b> 	<b>GB745R</b> 	<b>▲</b>
<b>GB741R</b> 	<b>GB746R</b> 	<b>GB746R</b> 	 <b>I</b>
<b>GB742R</b> 	<b>GB747R</b> 	<b>GB747R</b> 	 <b>II</b>
<b>GB743R</b> 	<b>GB748R</b> 	<b>GB748R</b> 	 <b>III</b>













Hi-Line  
XS























# AESULAP® BURRS & BLADES

## Hi-Line XS BURRS









Hi-Line XS Fräser  
Fraises Hi-Line XS  
Fresa Hi-Line XS  
Fresa Hi-Line XS



Ø	1.0 mm	1.4 mm	1.8 mm	2.3 mm	2.7 mm	3.1 mm	4.0 mm	4.5 mm	5.0 mm	6.0 mm	
											 sterile
I	GE401R	GE402R*	GE403R	GE404R	GE405R	GE406R	GE407R		GE408R	GE409R	Rosen
II	GE501R	GE502R	GE503R	GE504R	GE505R	GE506R	GE507R		GE508R	GE509R	
III			GE603R	GE604R	GE605R	GE606R	GE607R		GE608R	GE609R	
XLI				GE704R*		GE706R*	GE707R*		GE708R*	GE709R*	
XLII ②								GE282SU		GE281SU	
XLIII ②								GE292SU		GE291SU	

Ø	0.6 mm	1.0 mm	1.4 mm	1.8 mm	1.8 mm	2.3 mm	2.7 mm				
											 sterile
I ②	GE469SU	GE471SU			GE473SU		GE475SU				Rosen
II			GE572R*	GE573R*		GE574R*					

Ø	1.0 mm	1.4 mm	1.8 mm	2.3 mm	2.7 mm	3.1 mm	4.0 mm	4.5 mm	5.0 mm	6.0 mm	
											 sterile
I	GE411R	GE412R	GE413R	GE414R	GE415R	GE416R	GE417R		GE418R	GE419R	Diamond burr
II	GE511R	GE512R	GE513R	GE514R	GE515R	GE516R	GE517R		GE518R	GE519R	Diamantfräser
III			GE613R	GE614R	GE615R	GE616R	GE617R		GE618R	GE619R	Fraise à diamant
XLI				GE714R		GE716R*	GE717R		GE718R	GE719R*	Fresa diamante
XLII ②								GE286SU		GE284SU	Fresa a diamante
XLIII ②								GE296SU		GE294SU	





\* Only R version available; Nur als R Version verfügbar; Seulement disponible en version R; Solo disponible en versión R; Solo disponibile en versione R

Ø	0.6 mm	0.8 mm	1.0 mm	1.4 mm	1.8 mm	1.8 mm			
									
I ②	GE459SU	GE460SU	GE461SU			GE463SU			 sterile Diamond burr Diamantfräser Fraise diamantée Fresa diamantada Fresa diamantata
II				GE562R*	GE563R*				

Ø	2.3 mm	3.1 mm
		
I	GE424R*	GE425R*
II	GE524R*	GE525R*
III	GE624R*	GE625R*



 sterile

Diamond burr coarse  
 Diamantfräser grob  
 Fraise diamantée rugueuse  
 Fresa diamantada de grano grueso  
 Frese a diamante grosse

Ø	4.0 mm	5.0 mm	6.0 mm
			
I ②	GE456SU	GE457SU	
II ②	GE556SU	GE557SU	GE558SU
III ②	GE656SU	GE657SU	GE658SU

 sterile

Diamond burr extra coarse  
 Diamantfräser extra grob  
 Fraise diamantée très rugueuse  
 Fresa diamantada de grano extra grueso  
 Frese a diamante extra-grosse

Ø	5.0 mm	6.0 mm
		
▲	GE396R*	GE397R*







 sterile

Twin-Cut burr  
 Twin-Cut Fräser  
 Fraise Twin-Cut  
 Fresa Twin-Cut  
 Fresa Twin-Cut

# AESCULAP® BURRS & BLADES





## Hi-Line XS BURRS

Hi-Line XS Fräser  
 Fraises Hi-Line XS  
 Fresa Hi-Line XS  
 Fresa Hi-Line XS

Ø	1.8 mm	2.3 mm	3.1 mm	3.1 mm	3.1 mm	3.1 mm
						
I	GE435R					
II	GE531R*	GE534R	GE535R	GE553R	GE555R	
III	GE631R	GE634R	GE635R	GE653R	GE654R*	GE655R*
XLI						



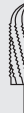

Neuro cutter  
 Olivenfräser  
 Fraise à olive  
 Fresa oliva  
 Fresa ad oliva

Ø	4.0 mm	5.0 mm	6.0 mm	4.0 mm
Soft cut				
I				
II	GE548R	GE549R	GE550R	
III	GE648R	GE649R	GE650R	GE645R*
XLI	GE711R*	GE729R*	GE712R	





Barrel burr  
 Walzenfräser  
 Fraise cylindrique  
 Fresa cilíndrica  
 Fresa tangenziale

Ø	4.0 mm	6.0 mm
Standard		
II	GE544R	GE546R
III	GE644R	GE646R



Barrel burr  
 Walzenfräser  
 Fraise cylindrique  
 Fresa cilíndrica  
 Fresa tangenziale

Ø	4.0 mm	6.0 mm
		
II	GE540R GE542R	
III		





Cone burr  
 Kegelfräser  
 Fraise conique  
 Fresa cónica  
 Fresa conica

Ø	4.0 mm
	
II	GE539R*
III	GE639R*

















Reverse taper burr  
 coarse diamond  
 Osteophytenfräser  
 Fraise pour ostéophytes  
 Fresa per resezione osteofiti  
 Fresa de diamante para osteofitos

Ø	6.0 mm
	
I	GE437R
II	GE537R













Acorn burr  
 Flammenfräser  
 Fraise flamme  
 Fresa flama  
 Fresa di flamma

Ø	4.0 mm	Ø	1.0 mm	1.1 mm	1.2 mm	1.5 mm	2.0 mm			②
										
II	GE536R*	▲	GE390R	GE391R	GE389R	GE395R		I	GE420R	GE429SU
		I				GE432R	GE433R	II	GE520R	GE529SU
		II				GE532R	GE533R	III	GE620R	GE629SU
		XLI ②				GE700SU				
 sterile		 sterile						 sterile		
Oval burr Ellipsenfräser Fraise elliptique Fresa elíptica Fresa elíptica		Twist drill Spiralbohrer Fraise spirale Broca espiral Punta elicoidal						Craniotome cutter Kraniotomfräser Fraise craniotome Fresa craneótomo Fresa di craniotomo		

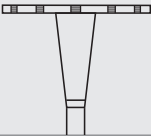
Hi-Line  
XS



 / Ø	12 mm / 1.4 mm	20 mm / 1.4 mm	Ø	1.0 mm	Ø	22.0 mm
						
▲			▲	GE392R	▲	
I			I		I ②	GE430SU
II	GE522R	GE523R	II	GE521R	II ②	GE530SU
 sterile			 sterile		 sterile	
Lindemann			Pin cutter Pinfräser Fraise pointue Fresa punta Fresa puntuale		Diamond disc Diamant-Trennscheibe Disque cou pant diamant Disco cortante de diamante Disco tagliente diamante	

# AESCALAP<sup>®</sup> BURRS & BLADES

## Hi-Line XS BURRS (TUNGSTEN CARBIDE)

Hi-Line XS Fräser (Hartmetall)



Fraises Hi-Line XS (Carbure)

Fresa Hi-Line XS (Carburo sinterizado)

Fresa Hi-Line XS (Carburo di tungsteno)



Ø	2.35 mm
	
II (2)	GE528SU
III (2)	GE628SU

 sterile

Ø	5.0 mm
	
II (2)	GE508TC-SU
III (2)	GE608TC-SU

 sterile

Rosen

Ø	3.1 mm
	
II (2)	GE535TC-SU
III (2)	GE635TC-SU



























 sterile

Neuro cutter  
Olivenfräser  
Fraise à olive  
Fresa oliva  
Fresa as oliva



# Hi-Line BURRS

Hi-Line Fräser  
 Fraises Hi-Line  
 Fresa Hi-Line  
 Fresa Hi-Line













<p><b>GB529R</b></p> 	<p><b>GB519R</b></p> 	 
<p><b>GB530R</b></p> 	<p><b>GB533R</b></p> 	 
<p><b>GB531R</b></p> 	<p><b>GB534R</b></p> 	 
<p><b>GB532R</b></p> 	<p><b>GB535R</b></p> 	 
<p><b>GB520R</b></p> 	<p><b>GB536R</b></p> 	 
	<p><b>GB537R</b></p> 	 
	<p><b>GB538R</b></p> 	 





















# AESCULAP® BURRS & BLADES

## Hi-Line BURRS

Hi-Line Fräser  
Fraises Hi-Line  
Fresa Hi-Line  
Fresa Hi-Line







Ø	1.0 mm	1.4 mm	2.3 mm	3.1 mm	4.5 mm	6.0 mm	8.0 mm			
										 sterile
					GD824R	GD825R				Rosen
			GD807R	GD738R	GD741R	GD744R	GD747R			
	GD733R	GD736R	GD808R	GD739R	GD742R	GD745R	GD748R			
			GD809R	GD740R	GD743R	GD746R	GD749R			

Ø	1.0 mm	1.4 mm	2.3 mm	3.1 mm	4.5 mm	6.0 mm				
										 sterile
					GD831R	GD832R				Diamond burr Diamantfräser Fraise à diamant Fresa diamante Fresa a diamante
			GD792R	GD795R	GD798R	GD801R				
	GD787R	GD790R	GD793R	GD796R	GD799R	GD802R				
			GD794R	GD797R	GD800R	GD803R				

Ø	2.3 mm	3.1 mm
		
		
	GD692R	GD695R
	GD693R	GD696R





 sterile

Diamond burr coarse  
Diamantfräser grob  
Fraise diamantée rugueuse  
Fresa diamantada de grano grueso  
Frese a diamante grosse

Ø	4.5 mm	6.5 mm
		
		
	GD714R	GD718R
	GD716R	GD719R

 sterile

Diamond burr extra coarse  
Diamantfräser extra grob  
Fraise diamantée très rugueuse  
Fresa diamantada de grano extra grueso  
Frese a diamante extra-grosse

Ø	
	
	GD804R
	GD805R
	GD806R

 sterile

Craniotome cutter  
Craniotomfräser  
Fraise craniotome  
Fresa craneótomo  
Fresa di craniotomo

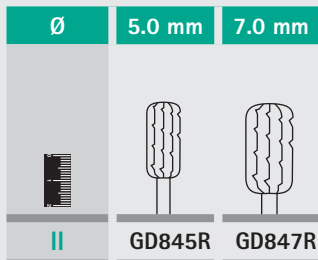

 sterile

Barrel burr  
Walzenfräser  
Fraise cylindrique  
Fresa cilíndrica  
Fresa tangenziale

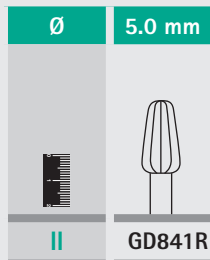

 sterile

Cone burr  
Kegelfräser  
Fraise conique  
Fresa cónica  
Fresa conica

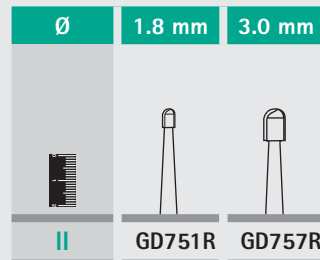

 sterile

Neuro cutter  
Olivenfräser  
Fraise à olive  
Fresa oliva  
Fresa ad oliva

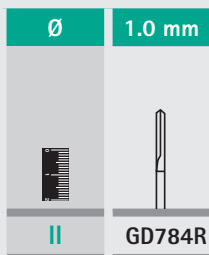

 sterile



Pin cutter  
Pinfräser  
Fraise pointue  
Fresa punta  
Fresa puntuale



# AESCULAP® BURRS & BLADES



## Hi-Line BURRS

Hi-Line Fräser  
 Fraises Hi-Line  
 Fresa Hi-Line  
 Fresa Hi-Line

Ø	1.5 mm	2.0 mm
		
▲	GD836R	GD837R
I	GD726R	GD729R
II	GD727R	GD730R

 sterile

Twist drill  
 Spiralbohrer  
 Fraise spirale  
 Broca espiral  
 Punta elicoidale

 / Ø	16 mm / 1.65 mm
	
▲	GD839R

 sterile

Lindemann

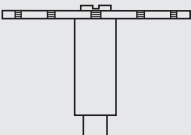
Ø	25 mm
	
II	GD763R

 sterile

Diamond disc  
 Diamant-Trennscheibe  
 Disque cou pant diamant  
 Disco cortante de diamante  
 Disco tagliente diamante

## 2.35 mm BURRS

2,35 mm Fräser  
 Fraises 2,35 mm  
 Fresa 2,35 mm  
 Fresa 2,35 mm

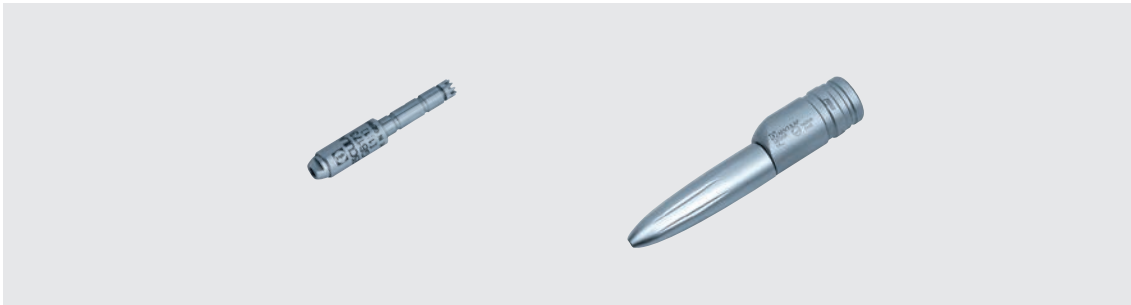

**GB173**

**GB376R/GB380R**

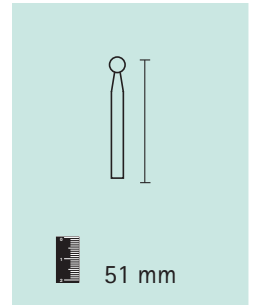

51 mm

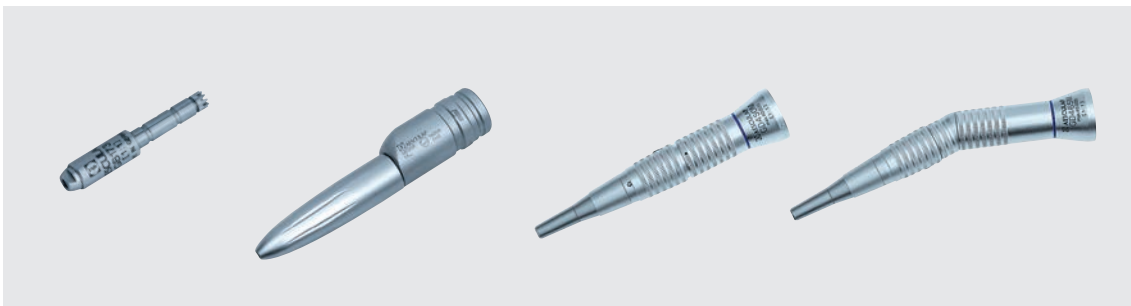

**GB173**

**GB376R/GB380R**

**GD450**

**GD465/GD455**

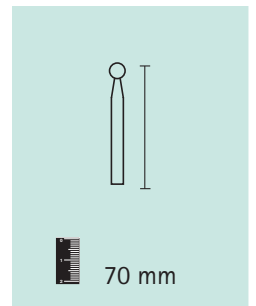

70 mm

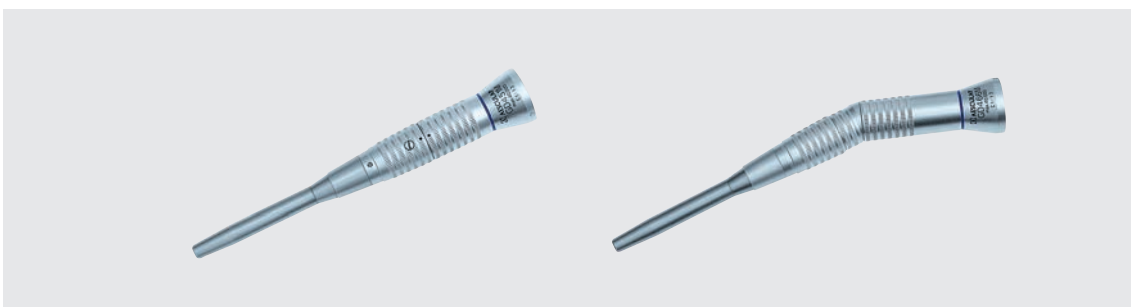

**GD451**

**GD466/GD456**

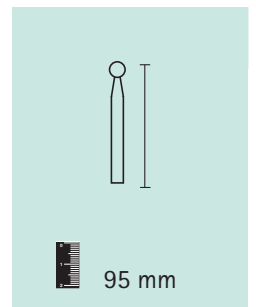

95 mm

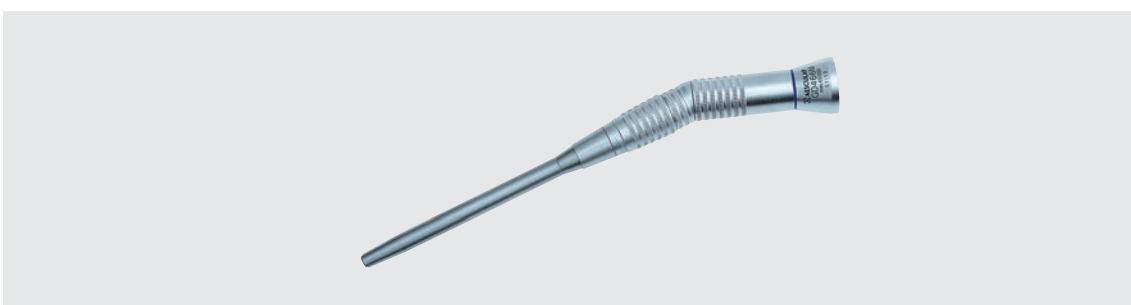

**GB124R**

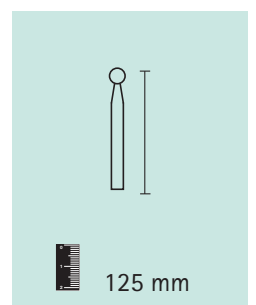

125 mm



2.35 mm



Ø mm	0.60	0.70	0.80	1.00	1.40	1.80	2.30	2.70	3.10	3.50	4.00	4.50	5.00	6.00	7.00
ISO	006	007	008	010	014	018	023	027	031	035	040	045	050	060	070

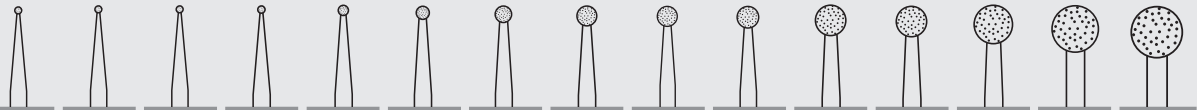
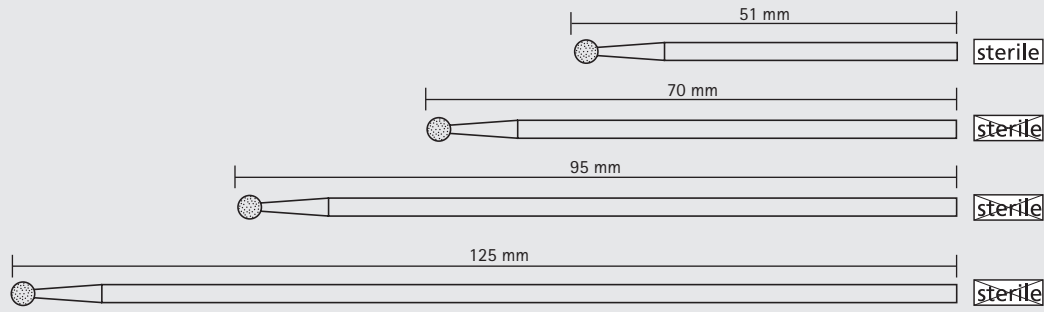

<b>51 mm</b>															
<b>70 mm</b>	GD021R	GD022R	GD023R	GD024R	GD025R	GD026R	GD027R	GD028R	GD029R	GD030R	GD031R	GD032R	GD033R	GD034R	GD035R
<b>95 mm</b>															
<b>125 mm</b>															



Diamond burr – Diamantfräser – Fraise diamantée – Fresa diamantada – Frese a diamante

2.35 mm







Ø	4.0 mm	5.0 mm	6.0 mm	7.0 mm				
70 mm								
	GD071R	GD072R	GD073R	GD074R				



Cone burr – Kegelfräser – Fraise conique – Fresa cónica – Fresa conica

Ø	4.0 mm	5.0 mm	6.0 mm	7.0 mm				
70 mm								
95 mm		GD182R		GD184R				
125 mm		GD282R		GD284R				

2.35 mm







Barrel burr – Walzenfräser – Fraise cylindrique – Fresa cilíndrica – Fresa tangenziale

# AESCULAP® BURRS & BLADES

## 2.35 mm BURRS

2,35 mm Fräser  
 Fraises 2,35 mm  
 Fresa 2,35 mm  
 Fresa 2,35 mm

 / Ø	4.0/1.2 mm	4.5/1.6 mm	23.0/2.2 mm					
								
	GD950R	GD951R	GD953R					
	TC	TC						

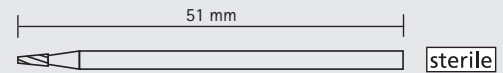

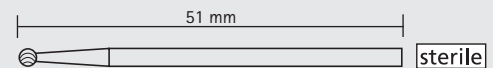

Tapér burr – Konusfräser – Fraise conique – Fresa cónica – Fresa conica

Ø	2.3 mm							
								
	GD961R							
	TC							



Rosen

 	Ø				
GC880R	1.4 mm	58 mm	28 mm		
GC884R	2 mm	65 mm	35 mm		
GC887R	2.7 mm	67 mm	37 mm		
GC890R	3.2 mm	67 mm	37 mm		

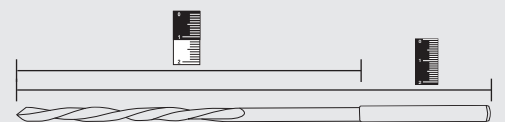

» GB173R



## TWIST DRILLS, INTRAMEDULLARY REAMERS

Spiralbohrer, Markraumbohrer

Forets hélicoïdaux, foret intramédullaire

Broca helicoidal, broca para cavidad medular

Perforatore spiralato, perforatore midollare



# AESULAP® BURRS & BLADES







## TWIST DRILLS, INTRAMEDULLARY REAMERS

Spiralbohrer, Markraumbohrer

Forets hélicoïdaux, foret intramédullaire





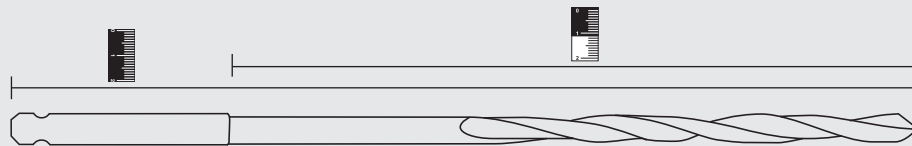

Broca helicoidal, broca para cavidad medular

Perforatore spiralato, perforatore midollare

 sterile	Ø			 sterile	Ø		
GC310R	1.1 mm	60 mm	35 mm	GC319R	3.2 mm	145 mm	120 mm
GC312R	1.5 mm	85 mm	60 mm	GC372R	3.2 mm	195 mm	170 mm
GC314R	2 mm	100 mm	75 mm	GC320R	3.5 mm	110 mm	85 mm
GC378R	2 mm	125 mm	100 mm	GC375R	3.5 mm	195 mm	170 mm
GC315R	2.5 mm	110 mm	85 mm	GC323R	4.5 mm	145 mm	120 mm
GC380R	2.5 mm	125 mm	100 mm	GC377R	4.5 mm	200 mm	175 mm
GC316R	2.7 mm	100 mm	75 mm				

AO  
small



 sterile	Ø			 sterile	Ø		
GC002R	1.5 mm	70 mm	45 mm	GC010R	3.5 mm	100 mm	75 mm
GC004R	2 mm	100 mm	75 mm	GC395R	3.5 mm	210 mm	170 mm
GC006R	2.5 mm	100 mm	75 mm	GC012R	4 mm	110 mm	85 mm
GC391R	2.5 mm	175 mm	135 mm	GC013R	4.5 mm	150 mm	125 mm
GC007R	2.8 mm	100 mm	75 mm	GC397R	4.5 mm	210 mm	170 mm
GC008R	3 mm	100 mm	75 mm	GC014R	5 mm	160 mm	135 mm
GC009R	3.2 mm	100 mm	75 mm	GC016R	6 mm	160 mm	135 mm





∅



GC355R	2.7/3.5/4 mm	130 mm	2.5 mm
GC354R	4.5 - 6.5 mm	130 mm	3.5 mm

AO  
small

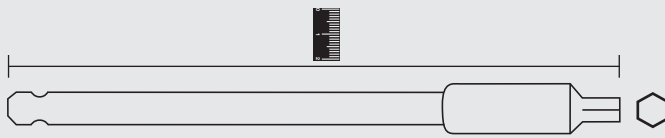

∅



GC461R	1.1 mm	65 mm	35 mm
GC491R	1.5 mm	28 mm	10 mm
GC462R	1.5 mm	75 mm	45 mm
GC464R	2 mm	90 mm	60 mm

GC458R	1.5 mm	50 mm

Dental

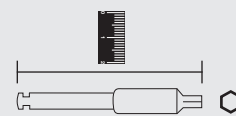
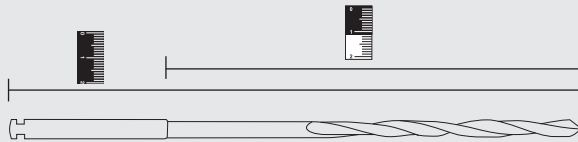

∅



GC880R	1.4 mm	58 mm	28 mm
GC884R	2 mm	65 mm	35 mm
GC887R	2.7 mm	67 mm	37 mm
GC890R	3.2 mm	67 mm	37 mm

» GB173R

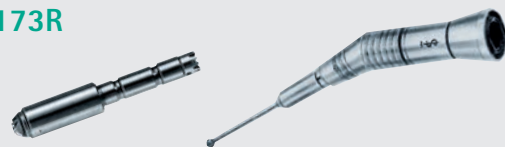

∅  
2.35 mm

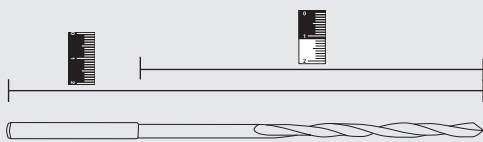

# AESULAP® BURRS & BLADES





## TWIST DRILLS, INTRAMEDULLARY REAMERS

Spiralbohrer, Markraumböhrer

Forets hélicoïdaux, foret intramédullaire

Broca helicoidal, broca para cavidad medular

Perforatore spiralato, perforatore midollare

 sterile	Ø	 sterile	Ø	 sterile	Ø	 sterile	Ø
GE668R*	9 mm	GE674R*	12 mm	GE682R*	16 mm	GE691R	21 mm
GE669R*	9.5 mm	GE675R*	12.5 mm	GE684R*	17 mm	GE692R	22 mm
GE670R*	10 mm	GE676R*	13 mm	GE685R	17.5 mm	GE693R	23 mm
GE671R*	10.5 mm	GE678R*	14 mm	GE686R*	18 mm	GE694R	24 mm
GE672R*	11 mm	GE679R	14.5 mm	GE688R*	19 mm		
GE673R*	11.5 mm	GE680R*	15 mm	GE690R	20 mm		

Burr head  
Bohrkopf  
Tête de forage  
Trépano  
Testa perforante

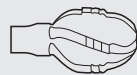

 sterile	
GE666R*	470 mm

Burr shaft  
Bohrerschaft  
Tige de forage  
Vástago de broca  
Gambo perforatore

AO



 sterile		Ø
GE663S*	800 mm	2.5 mm

Guide wire  
Führungsdraht  
Fil de guidage  
Alambre guía  
Filo guida



## SKULL PERFORATORS, CRANIOTOME BURRS

Schädeltrepane, Kraniotomfräser

Trépans crâniens, fraises de craniotome

Trépanos y fresas para craneótomo

Perforatori cranici, frese per craniotomia

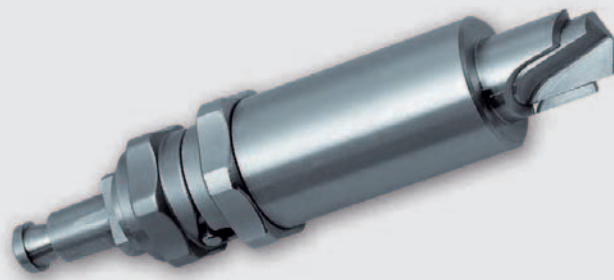

# AESCULAP® BURRS & BLADES

## SKULL PERFORATORS, CRANIOTOME BURRS

Schädeltrepane, Kraniotomfräser  
 Trépans crâniens, fraises de craniotome  
 Trépanos y fresas para craneótomo  
 Perforatori cranici, frese per craniotomia



Ø/mm

<b>GB300R</b>	6/9	4.0 mm*
<b>GB302R</b>	9/12	5.0 mm*
<b>GB304R</b>	12/15	5.4 mm*

Hudson

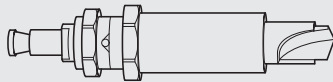

Ø/mm

<b>TE561</b>	6/9	4.0 mm*
<b>TE562</b>	9/12	5.0 mm*
<b>TE563</b>	12/15	5.4 mm*



\* Minimal cranial bone thickness  
 Mindestdicke des Schädelknochens  
 Épaisseur minimal de l'os crânien  
 Grosor mínimo del hueso craneal  
 Spessore minimo dell'osso cranico

\* Minimal cranial bone thickness  
 Mindestdicke des Schädelknochens  
 Épaisseur minimal de l'os crânien  
 Grosor mínimo del hueso craneal  
 Spessore minimo dell'osso cranico



Ø

<b>GC303R</b>	20 mm	1.6 mm
<b>GC307R</b>	20 mm	2.0 mm

GC303R



GC307R



» GB265R, GB268R



**GC304R**

» GB292

GC304R





## OTHERS

Sonstige  
Divers  
Otros  
Altro



etc.

# AESCULAP® BURRS & BLADES

## DERMATOLOGY

Dermatologie  
 Dermatologie  
 Dermatología  
 Dermatologia



**GB228R**

Wagner



» GA340, GA341, GB231R, GA670



Enlargement factor – Vergrößerungsfaktor – Facteur d'agrandissement – Factor de extensión – Fattore d'ingrandimento

**BA721**

1:1.5

**BA722**

1:3

**BA723**

1:6

» BA720R

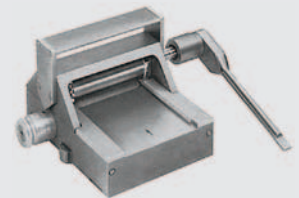

Skin Graft  
 Mesher



## CARE AND MAINTENANCE

Pflege und Aufbereitung  
 Entretien et maintenance  
 Conservación y mantenimiento  
 Cura e manutenzione



**GB600850**  
 ELAN 4 air

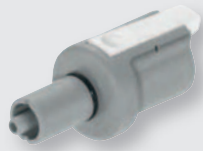

**GB600860**  
 ELAN 4 electro



**GB600880**  
 Acculan 4 small drill



**GB600840**  
 Acculan 4, Acculan 3Ti



**GB600870**  
 ELAN 4 MIS shafts,  
 microspeed uni XS



**GB600820**  
 HiLAN, HiLAN XS, Hi-Line  
 (XS, XXS), Microspeed EC,  
 microspeed uni, microLAN,  
 miniLAN



**GB600830**  
 mini-Line



**GB600810**  
 micro-Line



**GB600**  
 Sterilit Power Systems



etc.

# AESCALAP® BURRS & BLADES

## CARE AND MAINTENANCE

Pflege und Aufbereitung

Entretien et maintenance

Conservación y mantenimiento

Cura e manutenzione

ECCOS fixation for saw blades – ECCOS Halterungen für Sägeblätter – ECCOS fixation pour lames de scie – ECCOS soporte para hojas de sierra – ECCOS supporto per lame de sega

GB481R



GB729R

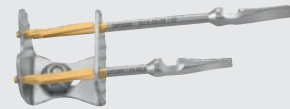

GB720R



GB730R



ECCOS fixation for burrs – ECCOS Halterungen für Fräser – ECCOS fixation pour fraises – ECCOS soporte para fresas – ECCOS supporto per frese

Hi-Line (XS)

GB613R

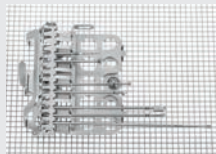

ELAN 4

GB718R



ECCOS fixation cranial perforator – ECCOS Halterung für Schädeltrepan – ECCOS fixation pour trepan cranien – ECCOS soporte para trepano cranial – ECCOS supporto per trapano craniale

GB572R

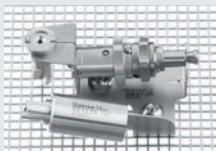

## INDEX, UNIVERSAL TOOL ATTACHMENTS, SIGNS AND SYMBOLS

Index, universelle Werkzeuganschlüsse, Zeichenerklärung

Sommaire, raccords d'outil universels, explication des symboles

Índice, conexiones universales para útiles, explicación de los símbolos

Indice, attacchi utensili universali, spiegazione dei simboli

A B C  
1 2 3

# AESCULAP® BURRS & BLADES





## INDEX, UNIVERSAL TOOL ATTACHMENTS, SIGNS AND SYMBOLS





Index, Universelle Werkzeuganschlüsse, Zeichenerklärung

Sommaire, Raccords d'outil universels, Explication des symboles

Índice, Conexiones universales para útiles, Explicación de los símbolos

Indice, Attacchi utensili universali, Spiegazione dei simboli

Art. No.		Art. No.		Art. No.		Art. No.		Art. No.	
BA721	74	GC138R	18	GC397R	68	GC683R	16	GD031R	63
BA722	74	GC139R	18	GC458R	69	GC761R	26	GD032R	63
BA723	74	GC148R	18	GC461R	69	GC766R	26	GD033R	63
		GC149R	18	GC462R	69	GC767R	26	GD034R	63
GB228R	74	GC203R	10	GC464R	69	GC768R	26	GD035R	63
GB300R	72	GC207R	10	GC491R	69	GC769R	26	GD041R	62
GB302R	72	GC208R	10	GC570R	37	GC770R	26	GD042R	62
GB304R	72	GC209R	10	GC575R	37	GC771R	26	GD043R	62
GB481R	76	GC211R	10, 15	GC576R	37	GC864R	64	GD044R	62
GB572R	76	GC215R	11	GC578R	37	GC866R	64	GD045R	62
GB600	75	GC216R	11	GC580R	37	GC867R	64	GD046R	62
GB600810	75	GC217R	11	GC583R	36	GC880R	66, 69	GD047R	62
GB600820	75	GC218R	11	GC584R	36	GC884R	66, 69	GD048R	62
GB600830	75	GC219R	11	GC585R	36	GC887R	66, 69	GD049R	62
GB600840	75	GC261R	34	GC586R	36	GC890R	66, 69	GD050R	62
GB600850	75	GC263R	34	GC587R	36	GC900R	62	GD051R	62
GB600860	75	GC265R	34	GC604R	19	GC901R	62	GD052R	62
GB600870	75	GC267R	34	GC605R	19	GC903R	62	GD053R	62
GB600880	75	GC269R	34	GC615R	24, 29	GC904R	62	GD054R	62
GB613R	76	GC271R	35	GC633R	24, 29	GC905R	29	GD055R	62
GB718R	76	GC273R	35	GC634R	19	GC906R	28	GD062R	64
GB720R	76	GC277R	35	GC635R	19	GC907R	28	GD063R	64
GB729R	76	GC279R	35	GC636R	19	GC909R	28	GD064R	64
GB730R	76	GC303R	72	GC640R	19	GC912R	28	GD071R	65
		GC304R	72	GC641R	19	GC915R	30	GD072R	65
GC002R	68	GC307R	72	GC642R	19	GC916R	30	GD073R	65
GC004R	68	GC310R	68	GC643R	19	GC919R	30	GD074R	65
GC006R	68	GC312R	68	GC644R	19	GC921R	30	GD081R	65
GC007R	68	GC314R	68	GC645R	19	GC923R	30	GD082R	65
GC008R	68	GC315R	68	GC646R	19	GC925R	30	GD083R	65
GC009R	68	GC316R	68	GC648R	20	GC926R	30	GD084R	65
GC010R	68	GC319R	68	GC649R	20	GC927R	29	GD125R	63
GC012R	68	GC320R	68	GC650R	20			GD126R	63
GC013R	68	GC323R	68	GC651R	20	GD021R	63	GD127R	63
GC014R	68	GC354R	69	GC652R	20	GD022R	63	GD128R	63
GC016R	68	GC355R	69	GC654R	29	GD023R	63	GD129R	63
GC114R	18	GC372R	68	GC655R	28	GD024R	63	GD130R	63
GC115R	18	GC375R	68	GC656R	28	GD025R	63	GD131R	63
GC124R	18	GC377R	68	GC657R	28	GD026R	63	GD132R	63
GC125R	18	GC378R	68	GC658R	28	GD027R	63	GD133R	63
GC127R	18	GC380R	68	GC675R	15	GD028R	63	GD134R	63
GC128R	18	GC391R	68	GC681R	15	GD029R	63	GD135R	63
GC137R	18	GC395R	68	GC682R	16	GD030R	63	GD145R	62

<b>Art. No.</b>		<b>Art. No.</b>		<b>Art. No.</b>		<b>Art. No.</b>		<b>Art. No.</b>	
GD146R	62	GD323R	27	GD794R	58	GE233SU	12	GE409R	52
GD147R	62	GD390R	17	GD795R	58	GE234SU	12	GE411R	52
GD148R	62	GD391R	17	GD796R	58	GE235SU	12	GE412R	52
GD149R	62	GD392R	17	GD797R	58	GE236SU	12	GE413R	52
GD150R	62	GD393R	17	GD798R	58	GE238SU	12	GE414R	52
GD151R	62	GD394R	17	GD799R	58	GE239SU	12	GE415R	52
GD152R	62	GD395R	17	GD800R	58	GE240SU	12	GE416R	52
GD153R	62	GD396R	17	GD801R	58	GE241SU	12	GE417R	52
GD154R	62	GD397R	17	GD802R	58	GE242SU	12	GE418R	52
GD155R	62	GD692R	58	GD803R	58	GE243SU	13	GE419R	52
GD162R	64	GD693R	58	GD804R	58	GE244SU	13	GE420R	55
GD164R	64	GD695R	58	GD805R	58	GE245SU	13	GE424R	53
GD182R	65	GD696R	58	GD806R	58	GE246SU	13	GE425R	53
GD184R	65	GD714R	58	GD807R	58	GE247SU	13	GE429SU	55
GD196R	64	GD716R	58	GD808R	58	GE248SU	13	GE430SU	55
GD225R	63	GD718R	58	GD809R	58	GE249SU	13	GE432R	55
GD226R	63	GD719R	58	GD824R	58	GE252R	14	GE433R	55
GD227R	63	GD726R	60	GD825R	58	GE253R	14	GE435R	54
GD228R	63	GD727R	60	GD831R	58	GE254R	14	GE437R	54
GD229R	63	GD729R	60	GD832R	58	GE255R	14	GE456SU	53
GD230R	63	GD730R	60	GD836R	60	GE281SU	52	GE457SU	53
GD231R	63	GD733R	58	GD837R	60	GE282SU	52	GE459SU	53
GD232R	63	GD736R	58	GD839R	60	GE284SU	52	GE460SU	53
GD233R	63	GD738R	58	GD841R	59	GE286SU	52	GE461SU	53
GD234R	63	GD739R	58	GD845R	59	GE291SU	52	GE463SU	53
GD235R	63	GD740R	58	GD847R	59	GE292SU	52	GE469SU	52
GD246R	62	GD741R	58	GD870R	62	GE294SU	52	GE471SU	52
GD247R	62	GD742R	58	GD873R	62	GE296SU	52	GE473SU	52
GD248R	62	GD743R	58	GD875R	62	GE389R	55	GE475SU	52
GD249R	62	GD744R	58	GD876R	62	GE390R	55	GE501R	52
GD250R	62	GD745R	58	GD877R	62	GE391R	55	GE502R	52
GD251R	62	GD746R	58	GD879R	62	GE392R	55	GE503R	52
GD252R	62	GD747R	58	GD895R	63	GE395R	55	GE504R	52
GD253R	62	GD748R	58	GD897R	63	GE396R	53	GE505R	52
GD254R	62	GD749R	58	GD899R	63	GE397R	53	GE506R	52
GD255R	62	GD751R	59	GD901R	63	GE401R	52	GE507R	52
GD262R	64	GD757R	59	GD950R	66	GE402R	52	GE508R	52
GD264R	64	GD763R	60	GD951R	66	GE403R	52	GE508TC-SU	56
GD282R	65	GD784R	59	GD953R	66	GE404R	52	GE509R	52
GD284R	65	GD787R	58	GD961R	66	GE405R	52	GE511R	52
GD320R	27	GD790R	58			GE406R	52	GE512R	52
GD321R	27	GD792R	58	GE231SU	12	GE407R	52	GE513R	52
GD322R	27	GD793R	58	GE232SU	12	GE408R	52	GE514R	52



# AESCULAP® BURRS & BLADES





## INDEX, UNIVERSAL TOOL ATTACHMENTS, SIGNS AND SYMBOLS

Index, Universelle Werkzeuganschlüsse, Zeichenerklärung





Sommaire, Raccords d'outil universels, Explication des symboles

Índice, Conexiones universales para útiles, Explicación de los símbolos

Indice, Attacchi utensili universali, Spiegazione dei simboli

Art. No.		Art. No.		Art. No.		Art. No.		Art. No.	
GE515R	52	GE606R	52	GE675R	70	GP123R	40	GP174R	42
GE516R	52	GE607R	52	GE676R	70	GP124R	40	GP175R	42
GE517R	52	GE608R	52	GE678R	70	GP124TC	44	GP176R	42
GE518R	52	GE608TC-SU	56	GE679R	70	GP125R	40	GP177R	42
GE519R	52	GE609R	52	GE680R	70	GP126R	40	GP184R	40
GE520R	55	GE613R	52	GE682R	70	GP126TC	44	GP185R	40
GE521R	55	GE614R	52	GE684R	70	GP127R	40	GP186R	40
GE522R	55	GE615R	52	GE685R	70	GP128R	40	GP187R	40
GE523R	55	GE616R	52	GE686R	70	GP128TC	44	GP188R	44
GE524R	53	GE617R	52	GE688R	70	GP129R	40	GP189R	44
GE525R	53	GE618R	52	GE690R	70	GP129TC	44	GP190R	44
GE528SU	56	GE619R	52	GE691R	70	GP133R	40	GP193R	44
GE529SU	55	GE620R	55	GE692R	70	GP134R	40	GP194R	44
GE530SU	55	GE624R	53	GE693R	70	GP135R	40	GP195R	44
GE531R	54	GE625R	53	GE694R	70	GP136R	40	GP196R	44
GE532R	55	GE628SU	56	GE700SU	55	GP141R	41	GP201R	43
GE533R	55	GE629SU	55	GE704R	52	GP142R	41	GP202R	43
GE534R	54	GE631R	54	GE706R	52	GP143R	41	GP203R	43
GE535R	54	GE634R	54	GE707R	52	GP144R	41	GP204R	43
GE535TC-SU	56	GE635R	54	GE708R	52	GP145R	41	GP205R	43
GE536R	55	GE635TC-SU	56	GE709R	52	GP146R	41	GP208R	43
GE537R	54	GE639R	54	GE711R	54	GP147R	41	GP209R	43
GE539R	54	GE644R	54	GE712R	54	GP148R	41	GP210R	43
GE540R	54	GE645R	54	GE714R	52	GP149R	41	GP210TC	44
GE542R	54	GE646R	54	GE716R	52	GP150R	41	GP211R	43
GE544R	54	GE648R	54	GE717R	52	GP151R	41	GP212R	43
GE546R	54	GE649R	54	GE718R	52	GP152R	41	GP213R	43
GE548R	54	GE650R	54	GE719R	52	GP153R	41	GP214R	43
GE549R	54	GE653R	54	GE729R	54	GP154R	41	GP215R	43
GE550R	54	GE654R	54			GP155R	41	GP216R	43
GE553R	54	GE655R	54	GP111R	40	GP156R	41	GP217R	43
GE555R	54	GE656SU	53	GP112R	40	GP157R	41	GP218R	43
GE556SU	53	GE657SU	53	GP113R	40	GP158R	41	GP219R	43
GE557SU	53	GE658SU	53	GP113TC	44	GP161R	42	GP220R	43
GE558SU	53	GE663S	70	GP114R	40	GP162R	42	GP224R	43
GE562R	53	GE666R	70	GP115R	40	GP163R	42	GP225R	43
GE563R	53	GE668R	70	GP116R	40	GP164R	42	GP226R	43
GE572R	52	GE669R	70	GP117R	40	GP165R	42	GP228R	43
GE573R	52	GE670R	70	GP118R	40	GP166R	42	GP229R	43
GE574R	52	GE671R	70	GP119TC	44	GP168R	42	GP230R	43
GE603R	52	GE672R	70	GP120R	40	GP169R	42	GP232R	44
GE604R	52	GE673R	70	GP121R	40	GP170R	42	GP233R	44
GE605R	52	GE674R	70	GP122R	40	GP173R	42	GP234R	43



<b>Art. No.</b>		<b>Art. No.</b>		<b>Art. No.</b>		<b>Art. No.</b>		<b>Art. No.</b>	
GP235R	43	GP341R	47	GP398SU	48	GP501R	7	GP567R	25
GP236R	43	GP342R	47	GP399TC-SU	48	GP502R	7	GP569R	24
GP238R	44	GP343R	47	GP420SU	50	GP504R	7	GP575R	24
GP240R	44	GP344R	47	GP421SU	50	GP505R	7	GP576R	24
GP241R	44	GP345R	47	GP422SU	50	GP511R	9	GP580R	32
GP242R	44	GP346R	47	GP423SU	50	GP514R	7	GP581R	33
GP243R	44	GP347R	47	GP424SU	50	GP515R	7	GP582R	32
GP301R	45	GP348R	47	GP425SU	50	GP516R	7	GP583R	33
GP301TC	48	GP349R	47	GP426SU	50	GP518R	7	GP584R	33
GP302R	45	GP350R	47	GP427SU	50	GP521R	7	GP586R	32
GP302TC	48	GP351R	47	GP428SU	50	GP522R	7	GP587R	33
GP303R	45	GP352R	47	GP429SU	50	GP523R	7	GP588R	33
GP304R	45	GP353R	47	GP430SU	50	GP524R	7	GP590R	32
GP304TC	48	GP355R	46	GP432SU	50	GP526R	9	GP591R	33
GP305R	45	GP356R	46	GP433SU	50	GP527R	9	GP594R	33
GP306R	45	GP357R	46	GP434SU	50	GP528R	9	GP595R	33
GP306TC	48	GP358R	46	GP435SU	50	GP529R	9	GP598R	33
GP307R	45	GP361R	46	GP436SU	50	GP530R	9		
GP307TC	48	GP362R	46	GP437SU	50	GP531R	9	TE561	72
GP308R	45	GP363R	46	GP440SU	50	GP532R	9	TE562	72
GP308TC	48	GP364R	46	GP441SU	50	GP535R	8	TE563	72
GP309R	45	GP367R	46	GP442SU	50	GP536R	8		
GP309TC	48	GP367TC	48	GP443SU	50	GP537R	8		
GP311R	45	GP370R	46	GP444SU	50	GP538R	8		
GP312R	45	GP371R	46	GP445SU	50	GP539R	8		
GP313R	45	GP374R	46	GP446SU	50	GP541R	22		
GP314R	45	GP375R	46	GP447SU	50	GP542R	22		
GP315R	45	GP376R	46	GP448SU	50	GP543R	22		
GP316R	45	GP378R	46	GP449SU	50	GP544R	22		
GP317R	45	GP379R	46	GP450SU	50	GP545R	22		
GP321R	45	GP380R	46	GP452SU	50	GP550R	24		
GP322R	45	GP382R	46	GP453SU	50	GP551R	23		
GP323R	45	GP384R	46	GP454SU	50	GP552R	23		
GP324R	45	GP385R	46	GP455SU	50	GP553R	23		
GP325R	45	GP386R	46	GP456SU	50	GP554R	23		
GP328R	45	GP388R	46	GP457SU	50	GP557R	25		
GP329R	45	GP389R	46	GP491R	6	GP558R	25		
GP330R	45	GP391R	47	GP492R	6	GP559R	24		
GP335R	47	GP392R	47	GP493R	6	GP561R	23		
GP336R	47	GP393R	47	GP494R	6	GP562R	23		
GP337R	47	GP395TC	48	GP495R	6	GP563R	23		
GP338R	47	GP396TC	48	GP496R	6	GP564R	23		
GP339R	47	GP397R	47	GP497R	6	GP565R	24		

# AESCALAP® BURRS & BLADES

## INDEX, UNIVERSAL TOOL ATTACHMENTS, SIGNS AND SYMBOLS

Index, Universelle Werkzeuganschlüsse, Zeichenerklärung

Sommaire, Raccords d'outil universels, Explication des symboles

Índice, Conexiones universales para útiles, Explicación de los símbolos

Indice, Attacchi utensili universali, Spiegazione dei simboli

### UNIVERSAL TOOL ATTACHMENTS – UNIVERSELLE WERKZEUGANSCHLÜSSE – RACCORDS D'OUTIL UNIVERSELS – CONEXIONES UNIVERSALES PARA ÚTILES – ATTACCHI UTENSILI UNIVERSALI

AO LARGE

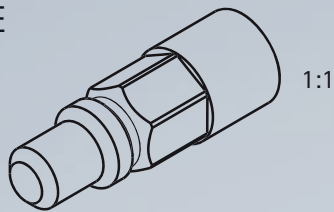

AO SMALL



DENTAL

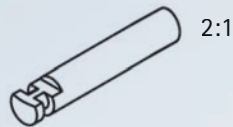

DIN

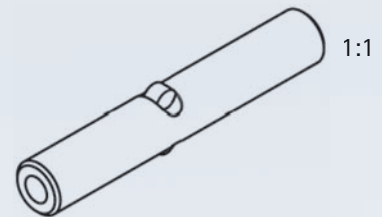

HARRIS

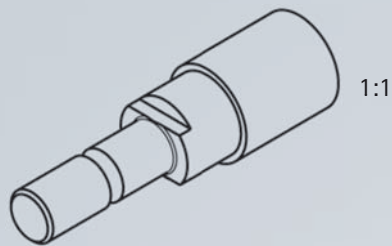

HUDSON

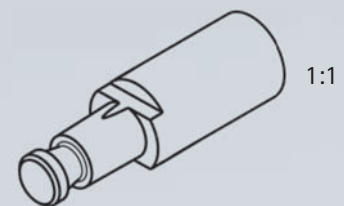

HEXAGON

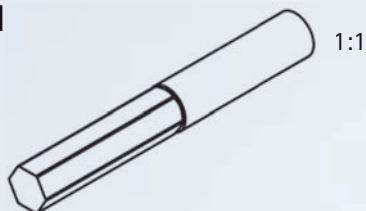

SYNTHES  
DHS/DCS

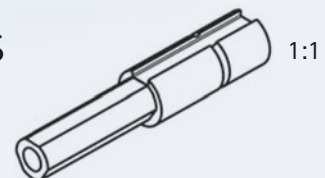

TRINKLE

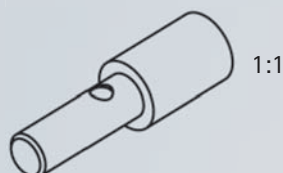

ZIMMER

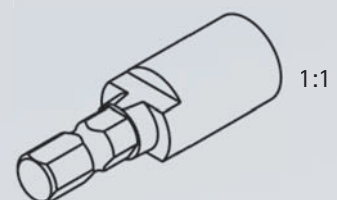

## SIGNS AND SYMBOLS – ZEICHENERKLÄRUNG – EXPLICATION DES SYMBOLES – EXPLICACIÓN DE LOS SIMBOLOS – SPIEGAZIONE DEI SIMBOLI



### › USEABLE WORKING SURFACE (E. G. OF SAWBLADES), IF NOT OTHERWISE INDICATED BY ACCOMPANYING ILLUSTRATION

Nutzlänge (z. B. bei Sägeblättern), wenn nicht per Skizze anders angegeben  
Longueur utile (p. ex. pour les lames de scie), sauf spécification contraire sur schéma  
Longitud útil (p.ej.: de las hojas de sierra), si no se indican otros datos en el croquis  
Lunghezza utile (ad es. per le lame da sega) se non diversamente indicato nel diagramma



### › BURR/BLADE LENGTH

Länge des Werkzeugs – Longueur de l'outil – Longitud de la herramienta – Lunghezza dell'utensile



### › BURR/BLADE WIDTH

Breite des Werkzeugs – Largeur de l'outil – Ancho de la herramienta – Larghezza dell'utensile



### › BURR/BLADE THICKNESS

Dicke des Werkzeugs – Épaisseur de l'outil – Espesor de la herramienta – Spessore dell'utensile



### › INCISION WIDTH: DIFFERENT FROM BLADE THICKNESS IN SAWBLADES WITH OFF-SET

Schnittspalt: weicht bei geschränkten Sägeblättern von der Dicke des Blattes ab  
Jeu de coupe: pour les lames de scie croisées, diffère de l'épaisseur de lame  
Ancho de corte: en las hojas de sierra triscadas difiere del espesor de la hoja  
Fessura di taglio: per le lame allicciate è diversa dallo spessore della lama



### › INCISION DEPTH

Schnitttiefe – Profondeur de coupe – Profundidad de corte – Profondità di taglio



### › DIAMETER OF BURR

Durchmesser des Werkzeugs – Diamètre de l'outil – Diámetro de la herramienta – Diametro dell'utensile

# AESCULAP® BURRS & BLADES

## INDEX, UNIVERSAL TOOL ATTACHMENTS, SIGNS AND SYMBOLS

Index, Universelle Werkzeuganschlüsse, Zeichenerklärung  
Sommaire, Raccords d'outil universels, Explication des symboles  
Índice, Conexiones universales para útiles, Explicación de los símbolos  
Indice, Attacchi utensili universali, Spiegazione dei simboli

## SIGNS AND SYMBOLS – ZEICHENERKLÄRUNG – EXPLICATION DES SYMBOLES – EXPLICACIÓN DE LOS SIMBOLOS – SPIEGAZIONE DEI SIMBOLI



### › DIAMETER OF BURR CANULATION

Durchmesser der Kanulierung des Werkzeugs – Diamètre de la canule de l'outil –  
Diámetro de la cánula de la herramienta – Diametro della cannula dell'utensile

TC

### › TUNGSTEN CARBIDE BURR

Hartmetallfräser – Mèche carbure – Broca de carburo sinterizado – Perforatore in carburo di tungsteno



### › PACKAGING UNIT

Verpackungseinheit – Unité de conditionnement – Unidad de embalaje – Unità di confezionamento



### › PACKED STERILE / UNSTERILE

Sterile/unsterile Verpackung – Emballage stérile/non stérile – Embalaje estéril/no estéril –  
Confezione sterile/non sterile



### › BURR / BLADE FOR SINGLE USE

Werkzeug zum Einmalgebrauch – Outil pour usage unique – Herramienta de un solo uso –  
Utensile monouso



### › FOR USE WITH HANDPIECE

Zur Verwendung mit Handstück – A utiliser avec la pièce à main – Utilizar con empuñadura –  
Da usarsi con il manipolo



### › PAGE

Seite – Page – Pagina – Pagina







# AESFULAP<sup>®</sup> – a B. Braun brand

Aesculap AG | Am Aesculap-Platz | 78532 Tuttlingen | Germany  
Phone +49 7461 95-0 | Fax +49 7461 95-2600 | [www.aesculap.com](http://www.aesculap.com)

The main product trademark "Aesculap" is a registered trademark of Aesculap AG.

Subject to technical changes. All rights reserved. This brochure may only be used for the exclusive purpose of obtaining information about our products. Reproduction in any form partial or otherwise is not permitted.